



Product Guide **ceramicx**

INFRARED FOR INDUSTRY

October 2020 | www.ceramicx.com



PORTABLE TEST STAND

Ceramicx' new Portable Test Stand allows for quick and consistent testing of materials. The interchangeable long, medium and short wave Infrared emitters are easily attached to the test stand.

The emitters face down and heat a material that is placed on a stainless steel mesh. The distance between emitter and material can easily be adjusted between 50mm and 200mm, in 50mm intervals.

This test stand allows the user to quickly determine the most suitable type of emitter and heating distance for a specific material, with consistent results due to the simple, repeatable test set up.

2 x 800 W, Black Ceramic SFEH

2 x 750 W, Quartz FQE

2 x 750 W, Tungsten QTS

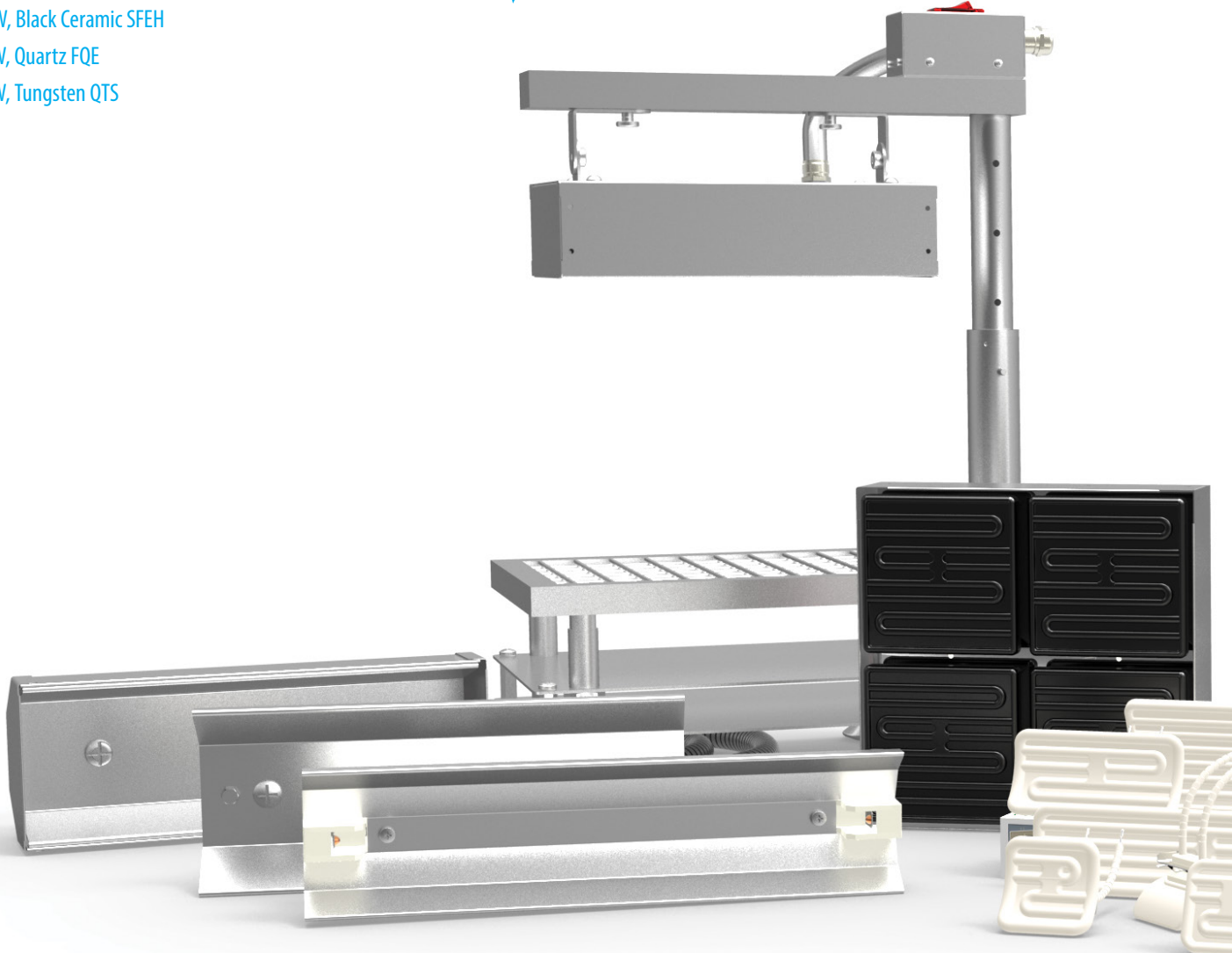
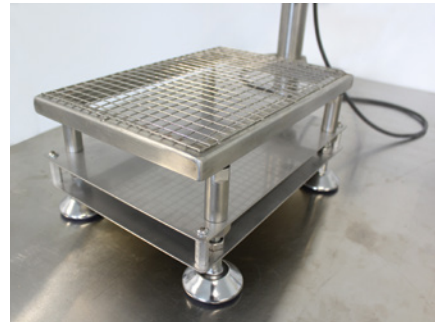



Ceramicx Product Guide

CERAMIC ELEMENTS

- 02 | Ceramic trough elements
- 04 | Ceramic hollow elements
- 06 | Ceramic flat elements
- 08 | Ceramic Edison screw elements

QUARTZ ELEMENTS

- 10 | Quartz elements
- 12 | Pillared quartz elements
- 12 | Single tube quartz heaters

PANEL HEATERS

- 13 | Panel heaters

QUARTZ TUNGSTEN/HALOGEN TUBES

- 14 | Quartz tungsten tubes
- 15 | Quartz halogen tubes

REFLECTORS AND PROJECTORS

- 16 | Reflectors RAS
- 17 | Quartz tungsten/halogen reflectors
- 17 | Projectors PAS

MODULAR IR HEATERS

- 18 | Modular IR 260 modular long wave infrared heater

FAST IR SYSTEMS

- 19 | Fast IR 305 / Fast IR 500

ACCESSORIES

- 20 | Ceramic terminal blocks
- 20 | Ceramic beads
- 21 | High temperature cable and cable sleeving





Ceramic Trough Elements

CERAMIC TROUGH ELEMENTS

Useful wavelength range 2 to 10 μm
 (FTE/HTE/QTE) are industry standard curved ceramic infrared heaters used in a wide range of industrial, commercial and domestic applications. These solid cast elements consist of a high temperature FeCrAl resistance alloy embedded in a specially formulated ceramic body allowing operating temperatures up to 750°C and a maximum power of 1000W (FTE Model Only).

All dimensions mm Tolerances apply

FTE

Full Trough Element,

Standard Wattages 150W 250W 300W 400W 500W 650W 750W 1000W.
 Standard Voltage 230V. Average weight 192g.

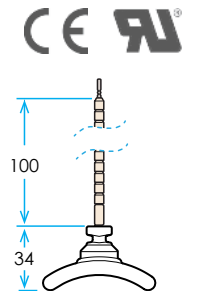
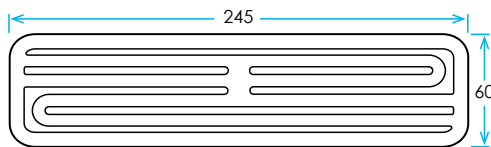

Wattage	150W	250W	300W	400W	500W	650W	750W	1000W
Mean surface temperature	272 °C	351 °C	405 °C	480 °C	515 °C	596 °C	624 °C	726 °C
Max power density	9 kW/m ²	15 kW/m ²	18 kW/m ²	24 kW/m ²	30 kW/m ²	39 kW/m ²	45 kW/m ²	60 kW/m ²
Radiant Watt density at 100mm	0.10 W/cm ²		0.26 W/cm ²		0.48 W/cm ²	0.69 W/cm ²		1.14 W/cm ²

Based on tests of average surface temperature with an infrared thermometer set at an emissivity of 0.95 (element mounted in an aluminised steel reflector, RAS)

HTE

Half Trough Element,

Standard Wattages 125W 150W 200W 250W 325W 400W 500W.
 Standard Voltage 230V. Average weight 105g.

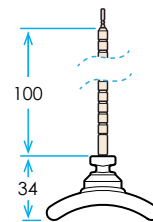
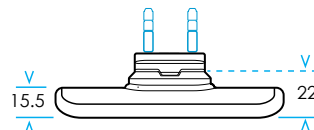
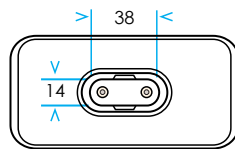
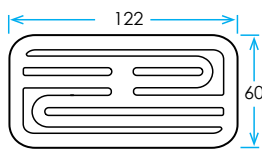

Wattage	125W	150W	200W	250W	325W	500W
Mean surface temperature	351 °C	405 °C	480 °C	515 °C	596 °C	726 °C
Max power density	15 kW/m ²	18 kW/m ²	24 kW/m ²	30 kW/m ²	39 kW/m ²	60 kW/m ²
Radiant Watt density at 100mm		0.26 W/cm ²		0.69 W/cm ²		1.14 W/cm ²

Based on tests of average surface temperature with an infrared thermometer set at an emissivity of 0.95 (element mounted in an aluminised steel reflector, RAS)

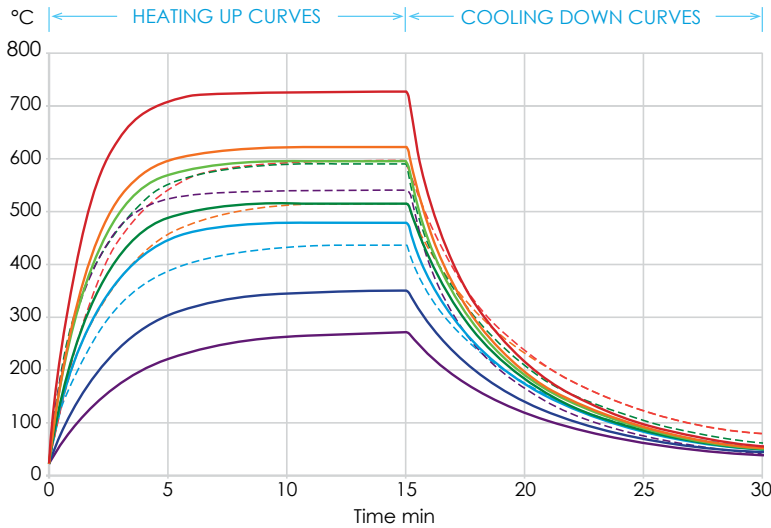

Heating up cooling down curves based on FTE tests of average surface temperature with an infrared thermometer set at an emissivity of 0.9

(element mounted in an aluminised steel reflector, RAS)

	FTE	HTE	QTE	
	1000W	500W	250W	- - - LFTE 1500W
	750W			- - - LFTE 1000W
	650W	325W		- - - QCE 250W
	500W	250W	125W	- - - QCE 150W
	400W	200W		
	250W	125W		
	150W			- - - FTEL-LN 1000W

QTE

Quarter Trough Element,

Standard Wattages 125W 250W. Standard Voltage 230V. Average weight 65g.

CE

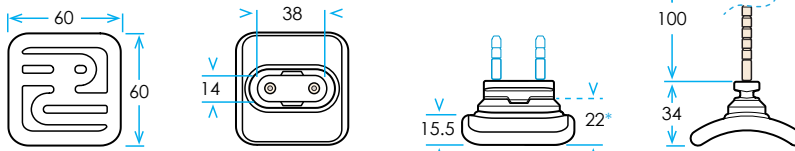

Wattage	125W	250W
Mean surface temperature	515 °C	726 °C
Max power density	30 kW/m ²	60 kW/m ²
Radiant Watt density at 100mm		1.14 W/cm ²

Based on tests of average surface temperature with an infrared thermometer set at an emissivity of 0.95 (element mounted in an aluminised steel reflector, RAS)

QCE

Quarter Curved Element

Standard Wattages 150W 250W.
Standard Voltage 230V.
Average weight 70g

CE

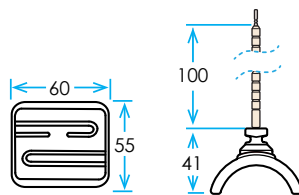

LFTE

Large Full Trough Element

Standard Wattages 1000W 1500W.
Standard Voltage 230V. Average weight 356g

CE

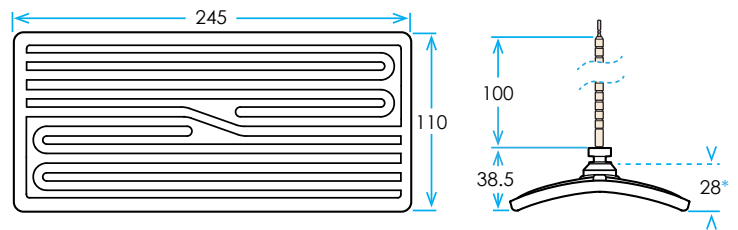

FTEL-LN

Full Trough Element Long - Long Neck,

Standard Wattage 1000W. Standard Voltage 230V.

CE

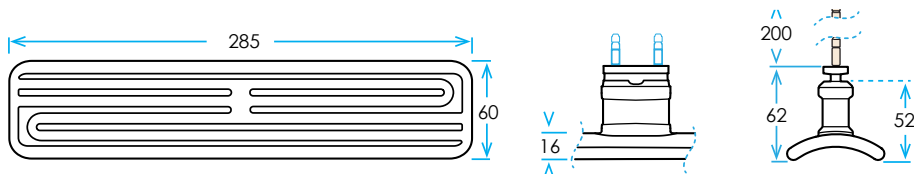

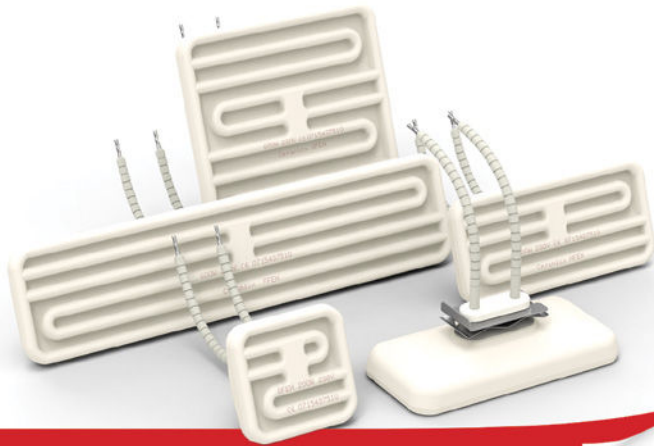

Ceramic Hollow Elements

CERAMIC HOLLOW ELEMENTS

Useful wavelength range 2 to 10 μm

Ceramic Hollow Elements (SFEH, FFEH, HFEH, QFEH) are industry standard ceramic emitters used in a wide range of industrial, commercial and domestic applications. The hollow constructed ceramic element has the advantage of having a shorter heat up time combined with increased energy efficiency. These hollow constructed products consist of a high temperature FeCrAl resistance alloy embedded in a specially formulated light weight hollow cast ceramic body which is subsequently filled with a high density insulating material. This results in a significant reduction in rear heat loss and increased radiant output from the front of the element, the operating temperature is up to a maximum of 750°C and a maximum power of 800W (FFEH and SFEH)

All dimensions mm Tolerances apply

FFEH

Full Flat Element Hollow,

Standard Wattages 250W 400W 500W 600W 800W. Standard Voltage 230V. Average weight 250g.

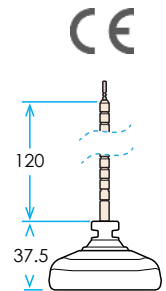
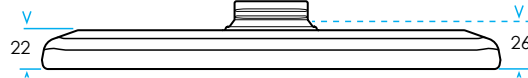
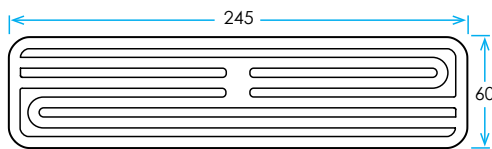

Wattage	250W	400W	500W	600W	800W
Mean surface temperature	390 °C	497 °C	548 °C	602 °C	710 °C
Max power density	15 kW/m ²	24 kW/m ²	30 kW/m ²	36 kW/m ²	48kW/m ²
Radiant Watt density at 100mm	0.25 W/cm ²	0.44 W/cm ²		0.73 W/cm ²	

Based on tests of average surface temperature with an infrared thermometer set at an emissivity of 0.95 (element mounted in an aluminised steel reflector, RAS)

HFEH

Half Flat Element Hollow,

Standard Wattages 125W 200W 250W 300W 400W. Standard Voltage 230V. Average weight 117g.

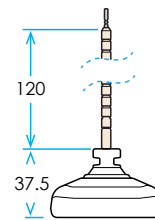
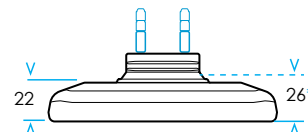
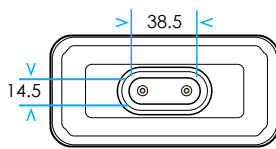
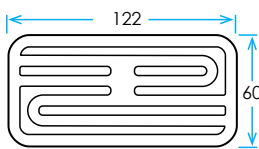

Wattage	125W	200W	250W	300W	400W
Mean surface temperature	390 °C	497 °C	548 °C	602 °C	710 °C
Max power density	15 kW/m ²	24 kW/m ²	30 kW/m ²	36 kW/m ²	48kW/m ²
Radiant Watt density at 100mm		0.31 W/cm ²		0.49 W/cm ²	

Based on tests of average surface temperature with an infrared thermometer set at an emissivity of 0.95 (element mounted in an aluminised steel reflector, RAS)

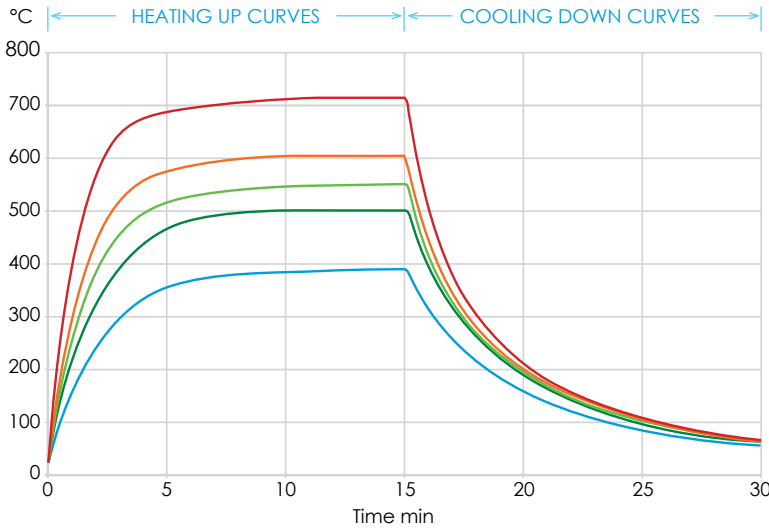

Heating up cooling down curves based on FTE tests of average surface temperature with an infrared thermometer set at an emissivity of 0.9

(element mounted in an aluminised steel reflector, RAS)

	FFEH	HFEH	QFEH	SFEH
—	800W	400W	200W	800W
—	600W	300W		600W
—	500W	250W	125W	500W
—	400W	200W		400W
—	250W	125W		250W

QFEH

Quarter Flat Element Hollow,

Standard Wattages 125W 200W. Standard Voltage 230V. Average weight 75g.

CE

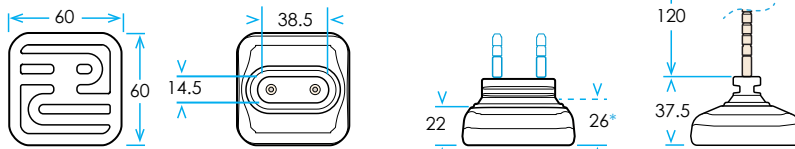

Wattage	125W	200W
Mean surface temperature	548 °C	710 °C
Max power density	30 kW/m ²	48kW/m ²

Based on tests of average surface temperature with an infrared thermometer set at an emissivity of 0.95 (element mounted in an aluminised steel reflector, RAS)

SFEH

Square Flat Element Hollow,

Standard Wattages 250W 400W 500W 600W 800W. Standard Voltage 230V. Average weight 239g.

CE

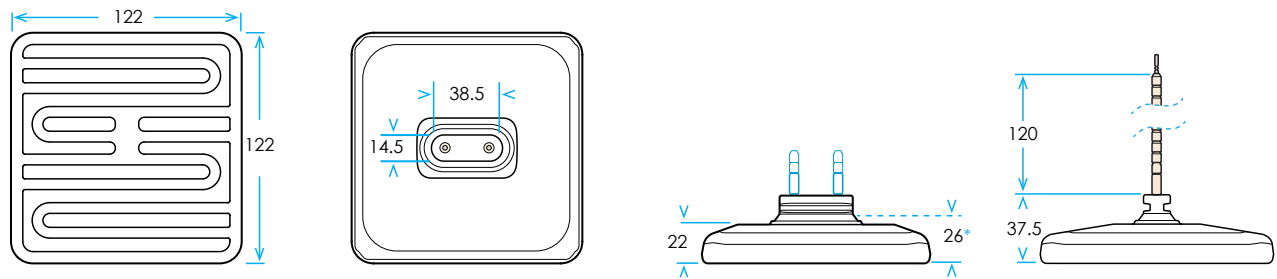

Wattage	250W	400W	500W	600W	800W
Mean surface temperature	390 °C	497 °C	548 °C	602 °C	710 °C
Max power density	15 kW/m ²	24 kW/m ²	30 kW/m ²	36 kW/m ²	48kW/m ²
Radiant Watt density at 100mm	0.28 W/cm ²	0.51W/cm ²		0.81 W/cm ²	1.18W/cm ²

Based on tests of average surface temperature with an infrared thermometer set at an emissivity of 0.95 (element mounted in an aluminised steel reflector, RAS)



Ceramic Flat Elements

CERAMIC FLAT ELEMENTS

Useful wavelength range 2 to 10 μm

Ceramic IR Flat Elements (FFE/HFE/QFE) are industry standard ceramic emitters used in a wide range of industrial, commercial and domestic applications. These solid cast ceramic elements consist of a high temperature FeCrAl resistance alloy embedded in a specially formulated ceramic body allowing operating temperatures up to 750°C and a maximum power output of 1000W (FFE Model Only). The solid cast heater body is flat, producing a diffuse radiant output to target distance in some applications.

All dimensions mm Tolerances apply

FFE

Full Flat Element,

Standard Wattages 150W 250W 300W 400W 500W 650W 750W 1000W. Standard Voltage 230V. Average weight 182g.

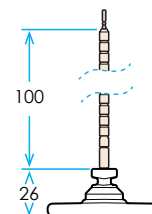
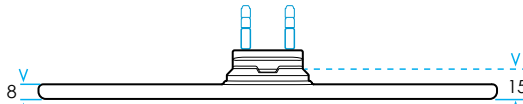
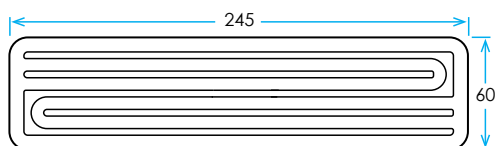

Wattage	150W	250W	300W	400W	500W	650W	750W	1000W
Mean surface temperature	272 °C	351 °C	405 °C	480 °C	515 °C	596 °C	624 °C	726 °C
Max power density	9 kW/m ²	15 kW/m ²	18 kW/m ²	24 kW/m ²	30 kW/m ²	39 kW/m ²	45 kW/m ²	60 kW/m ²
Radiant Watt density at 100mm	0.10 W/cm ²		0.25 W/cm ²		0.47W/cm ²			

Based on tests of average surface temperature with an infrared thermometer set at an emissivity of 0.95 (element mounted in an aluminised steel reflector, RAS)

HFE

Half Flat Element,

Standard Wattages 125W 150W 200W 250W 325W 500W. Standard Voltage 230V. Average weight 105g.

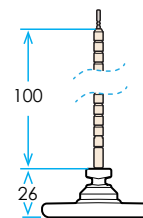
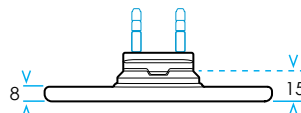
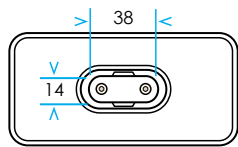
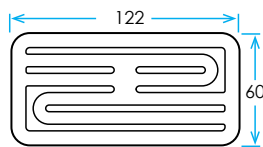

Wattage	125W	150W	200W	250W	325W	500W
Mean surface temperature	351 °C	405 °C	480 °C	515 °C	596 °C	726 °C
Max power density	15 kW/m ²	18 kW/m ²	24 kW/m ²	30 kW/m ²	39 kW/m ²	60 kW/m ²

Based on tests of average surface temperature with an infrared thermometer set at an emissivity of 0.95 (element mounted in an aluminised steel reflector, RAS)

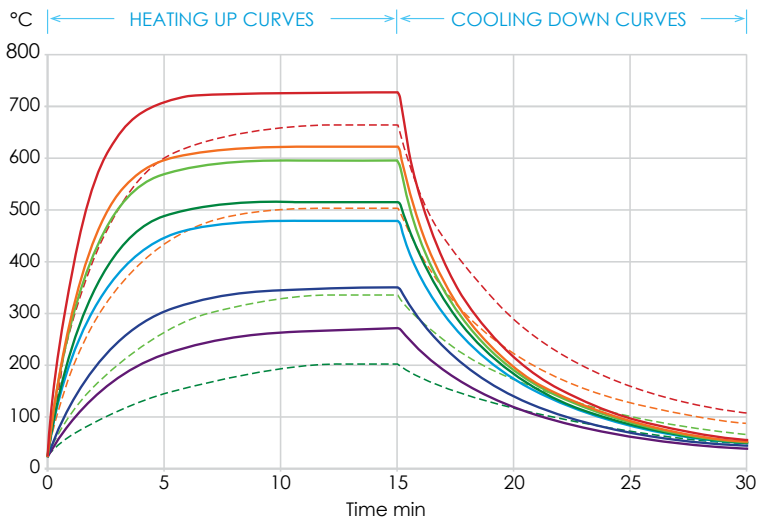

Heating up cooling down curves based on FFE tests of average surface temperature with an infrared thermometer set at an emissivity of 0.9
(element mounted in an aluminised steel reflector, RAS)

	FFE	HFE	QFE	SFSE		LFSE
	1000W	500W	250W			1400W
	750W			750W		750W
	650W	325W		650W		350W
	500W	250W	125W	500W		150W
	400W	200W		400W		
	250W	125W		250W		
	150W			150W		

QFE

Quarter Flat Element,

Standard Wattages 125W 250W. Standard Voltage 230V. Average weight 65g.

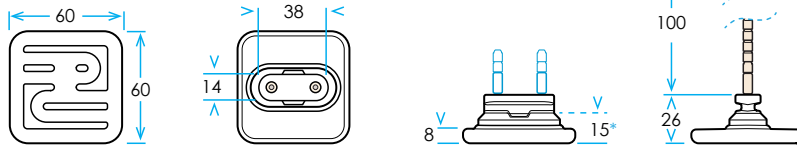

Wattage	125W	250W
Mean surface temperature	515 °C	726 °C
Max power density	30 kW/m ²	60 kW/m ²

Based on tests of average surface temperature with an infrared thermometer set at an emissivity of 0.95 (element mounted in an aluminised steel reflector, RAS)

SFSE

Square Flat Solid Element,

Standard Wattages 250W 400W 500W 600W 800W. Standard Voltage 230V. Average weight 192g.

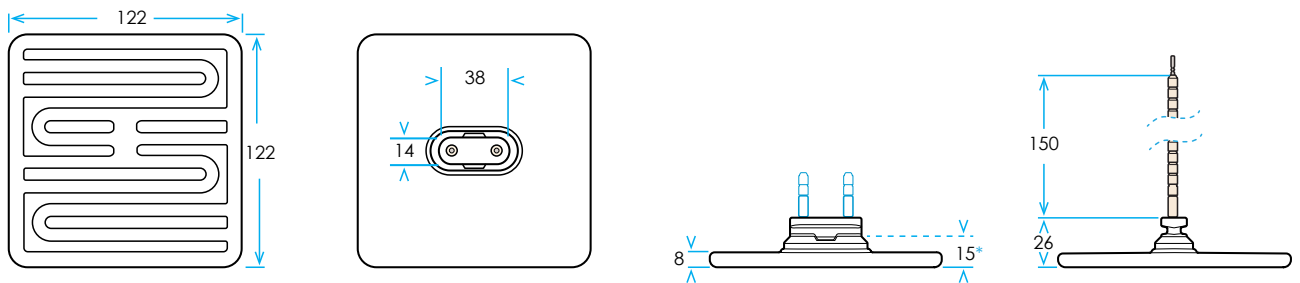

Wattage	150W	250W	300W	400W	500W	650W	750W
Mean surface temperature	272 °C	351 °C	405 °C	480 °C	515 °C	596 °C	624 °C
Max power density	9 kW/m ²	15 kW/m ²	18 kW/m ²	24 kW/m ²	30 kW/m ²	39 kW/m ²	45 kW/m ²
Radiant Watt density at 100mm		0.23 W/cm ²		0.39 W/cm ²		0.71 W/cm ²	0.81 W/cm ²

Based on tests of average surface temperature with an infrared thermometer set at an emissivity of 0.95 (element mounted in an aluminised steel reflector, RAS)

LFFE

Large Full Fat Element,

Standard Wattages 150W 350W 750W 1400W. Standard Voltage 230V. Average weight 342g.

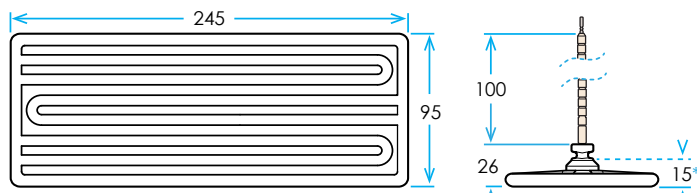

Wattage	150W	350W	750W	1400W
Mean surface temperature	204 °C	338 °C	501 °C	667 °C
Max power density	5.4 kW/m ²	12 kW/m ²	27 kW/m ²	50 kW/m ²

Based on tests of average surface temperature with an infrared thermometer set at an emissivity of 0.95 (element mounted in an aluminised steel reflector, RAS)



CERAMIC EDISON SCREW ELEMENTS

Useful wavelength range 2 to 10 µm

Ceramic Edison Screw Elements (ESEB, ESES, ESER, ESEXL) are industry standard infrared bulbs used primarily in the area of reptile/animal/ pet health care. These ceramic bulbs provide the infrared heat required without any of the negative effects of a light output that can disturb the day/night sleeping cycle of the reptile/animal. Ceramicx hollow cast bulbs consist of a high temperature FeCrAl resistance alloy embedded in a specially formulated ceramic body allowing operating temperature up to 530°C and a maximum power of 400W (ESEXL Model Only). The face of the ESEB is circular and convex in design, producing a circular outward trending radiant output.

All dimensions mm Tolerances apply

ESES

Edison Screw Element Small,

Standard Wattages 60W 100W.
Standard Voltage 230V. Average weight 113g

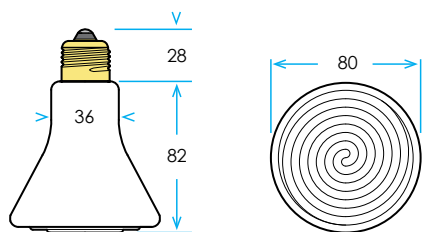

ESER

Edison Screw Element Regular,

Standard Wattages 150W 250W.
Standard Voltage 230V. Average weight 165g

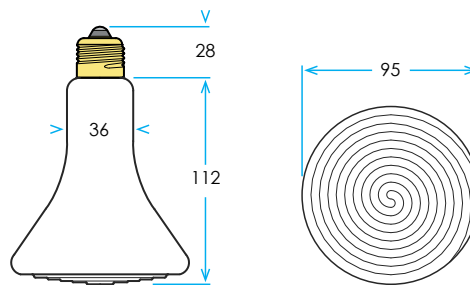

ESEB

Edison Screw Element Bulb,

Standard Wattages 60W 100W.

Standard Voltage 230V. Average weight 112g

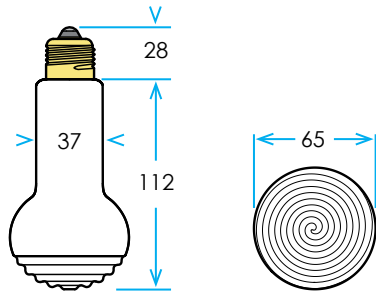

ESEL

Edison Screw Element Large,

Standard Wattages 300W 400W.

Standard Voltage 230V. Average weight 253g

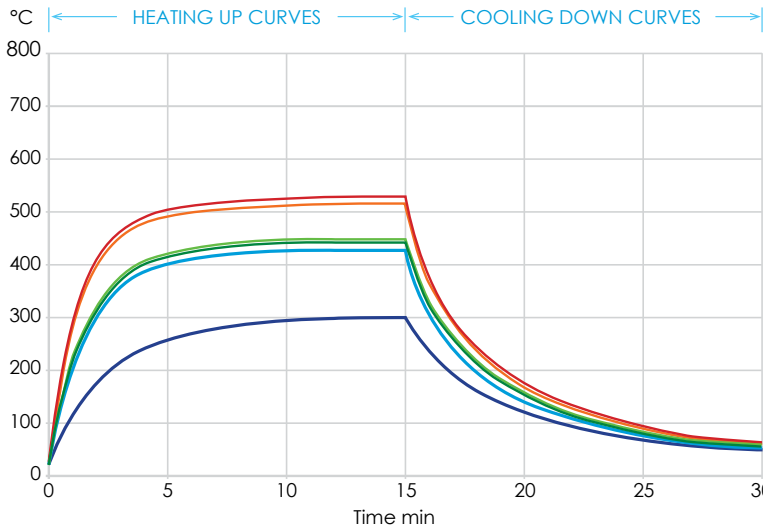
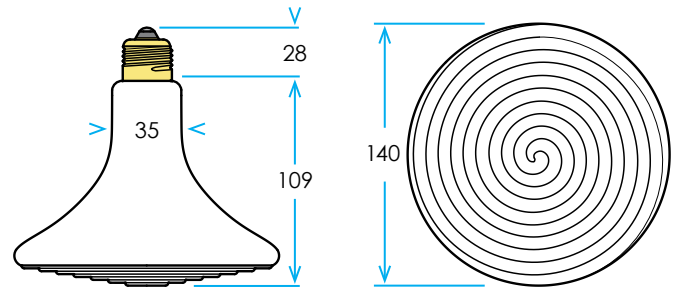

Heating up cooling down curves based on tests of average surface temperature with an infrared thermometer set at an emissivity of 0.9 (element mounted in an aluminised steel reflector, RAS)

	ESES	ESER	ESEB	ESEL
				400W
		250W		
				300W
		150W		
	100W		100W	
	60W		60W	

Wattage

ESES

60W

100W

ESER

150W

250W

ESEB

60W

100W

ESEL

300W

400W

Mean surface temperature

300°C

426°C

441°C

516°C

300°C

426°C

450°C

530°C

Max power density

7.3kW/m²

12 kW/m²

15kW/m²

25 kW/m²

13.5kW/m²

22.5 kW/m²

22.5kW/m²

30 kW/m²

Based on tests of average surface temperature with an infrared thermometer set at an emissivity of 0.9



Quartz Elements

QUARTZ ELEMENTS

Useful wavelength range 1.5 to 8µm

Quartz infrared heating elements provide medium wave infrared radiation. They are favoured in industrial applications where a more rapid heater response is necessary, including systems with long heater off cycles.

Quartz infrared heating elements are particularly effective in systems where rapid heater response and/or zone controlled heating is required. They have a broad emission spectrum from around 1.4 to 8 microns, slightly shorter in wavelength than ceramic elements.

Pillared quartz elements have the same mounting fixture as ceramic elements allowing easy replacement.

All dimensions mm Tolerances apply

FQE

Full Quartz Element,

Standard Wattages 150W 250W 300W 400W 500W 650W 750W 1000W. Standard Voltage 230V. Average weight 403g.

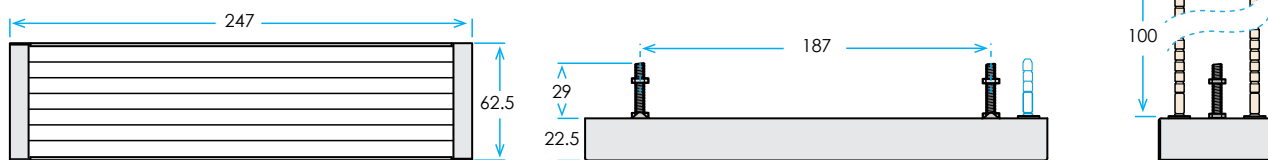

Wattage	150W	250W	300W	400W	500W	650W	750W	1000W
Mean surface temperature	343 °C	438 °C	477 °C	542 °C	593 °C	664 °C	690 °C	772 °C
Max power density	9 kW/m ²	15 kW/m ²	18 kW/m ²	24 kW/m ²	30 kW/m ²	39 kW/m ²	45 kW/m ²	60 kW/m ²
Radiant Watt density at 100mm	0.10 W/cm ²		0.26 W/cm ²		0.48 W/cm ²	0.69 W/cm ²		1.14 W/cm ²

Based on tests of average surface temperature with an infrared thermometer set at an emissivity of 0.95 (element mounted in an aluminised steel reflector, RAS)

HQE

Half Quartz Element,

Standard Wattages 150W 250W 325W 400W 500W. Standard Voltage 230V. Average weight 210g.

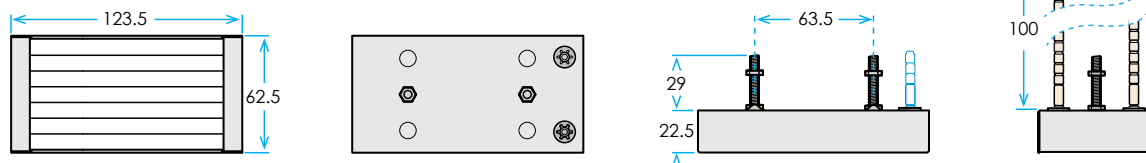

Wattage	150W	250W	325W	400W	500W
Mean surface temperature	477 °C	593 °C	664 °C	709 °C	772 °C
Max power density	18 kW/m ²	30 kW/m ²	39 kW/m ²	48 kW/m ²	60 kW/m ²
Radiant Watt density at 100mm	0.26 W/cm ²		0.69 W/cm ²		1.14 W/cm ²

Based on tests of average surface temperature with an infrared thermometer set at an emissivity of 0.95 (element mounted in an aluminised steel reflector, RAS)

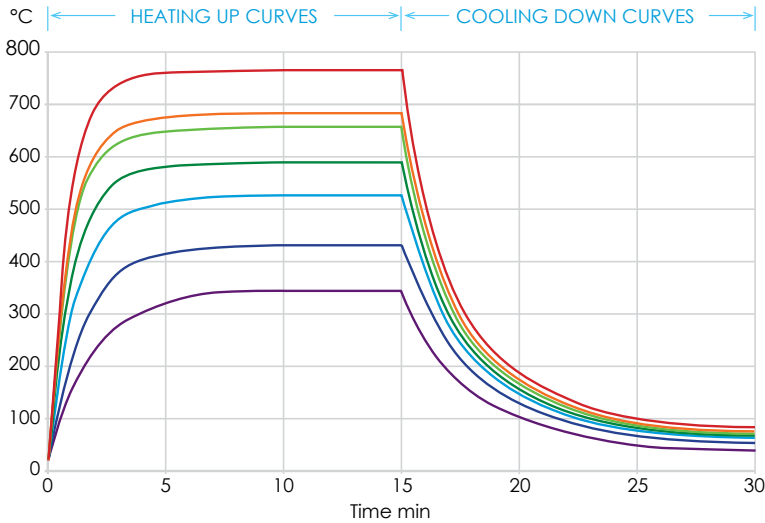

Heating up cooling down curves based on FQE tests of average surface temperature with an infrared thermometer set at an emissivity of 0.7

(element mounted in an aluminised steel reflector, RAS)

	FQE	HQE	QQE	SQE
—	1000W	500W	250W	1000W
—	750W			750W
—	650W	325W		650W
—	500W	250W		500W
—	400W			400W
—	250W			250W
—	150W			150W
	PFQE	PHQE		

QQE

Quarter Quartz Element,

Standard Wattages 150W 250W. Standard Voltage 230V. Average weight 144g.

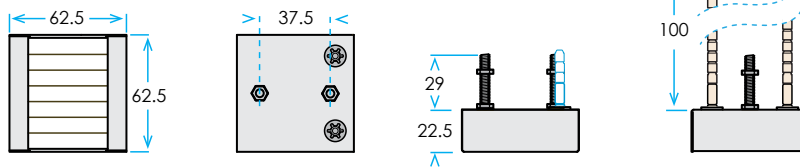

Wattage	150W	250W
Mean surface temperature	642 °C	772 °C
Max power density	36 kW/m ²	60 kW/m ²
Radiant Watt density at 100mm		1.14 W/cm ²

Based on tests of average surface temperature with an infrared thermometer set at an emissivity of 0.95 (element mounted in an aluminised steel reflector, RAS)

SQE

Square Quartz Element,

Standard Wattages 150W 250W 300W 400W 500W 650W 750W 1000W. Standard Voltage 230V. Average weight 401g.

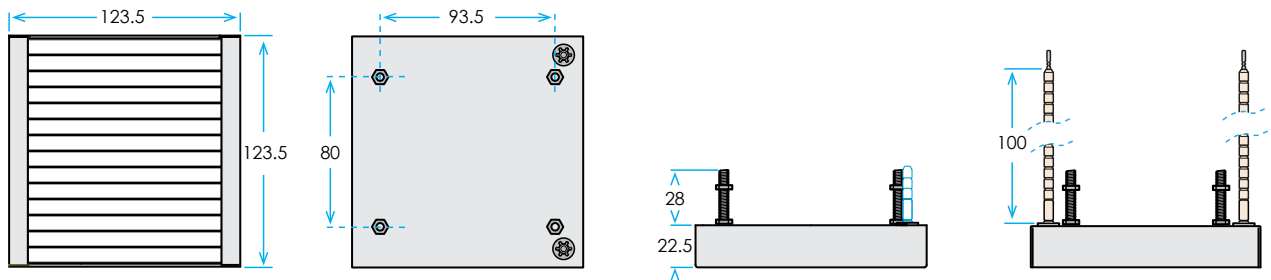

Wattage	150W	250W	300W	400W	500W	650W	750W	1000W
Mean surface temperature	343 °C	438 °C	477 °C	542 °C	593 °C	664 °C	690 °C	772 °C
Max power density	9 kW/m ²	15 kW/m ²	18 kW/m ²	24 kW/m ²	30 kW/m ²	39 kW/m ²	45 kW/m ²	60 kW/m ²

Based on tests of average surface temperature with an infrared thermometer set at an emissivity of 0.95 (element mounted in an aluminised steel reflector, RAS)

PFQE

Pillared Full Quartz Element,

Standard Wattages 150W 250W 400W 500W 650W 750W 1000W. Standard Voltage 230V. Average Weight 403g

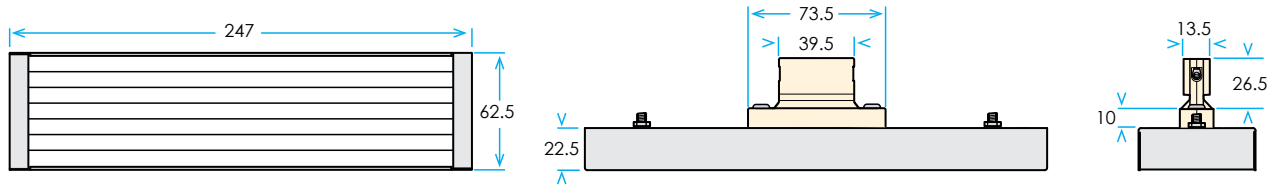

PHQE

Pillared Half Quartz Element,

Standard Wattages 150W 250W 400W 500W. Standard Voltage 230V. Average Weight 268g

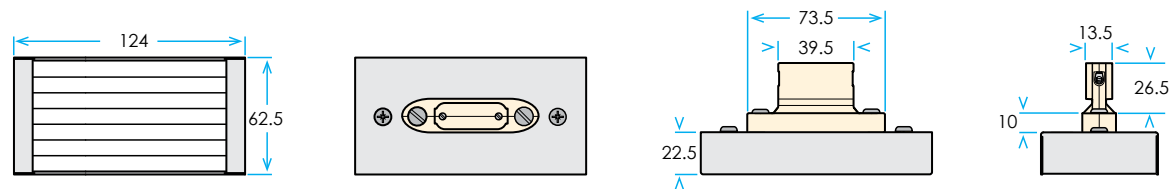

STQH 100

Single Tube Quartz Heater 100,

Standard Wattage Range 150W - 400W Standard Voltage 230V.

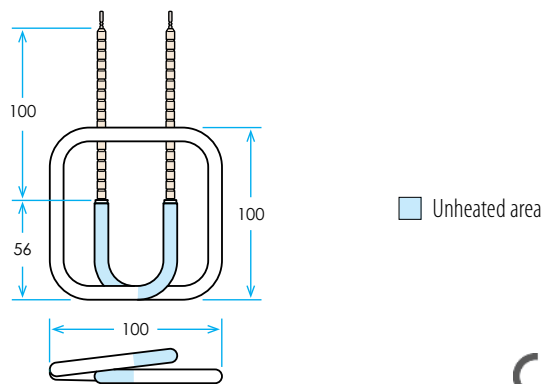

STQH 112

Single Tube Quartz Heater 112,

Standard Wattage Range 150W - 400W Standard Voltage 230V.

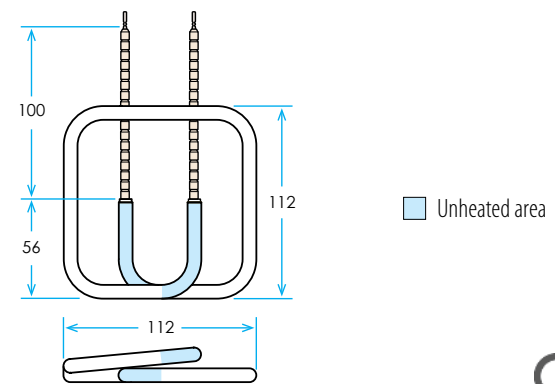

STQH 140

Single Tube Quartz Heater 140,

Standard Wattage Range 150W - 650W Standard Voltage 230V.

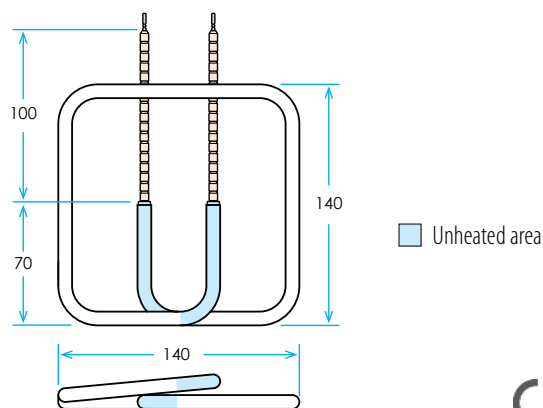

STQH 150

Single Tube Quartz Heater 150,

Standard Wattage Range 150W - 650W Standard Voltage 230V.

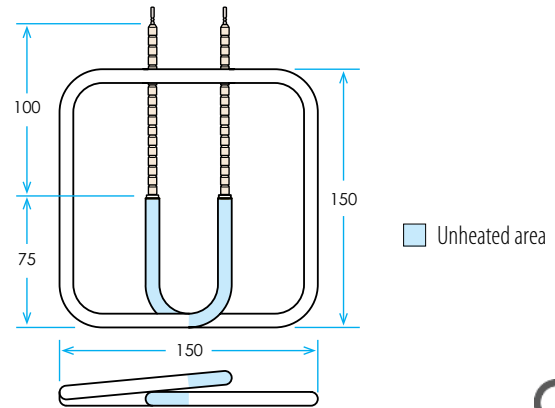

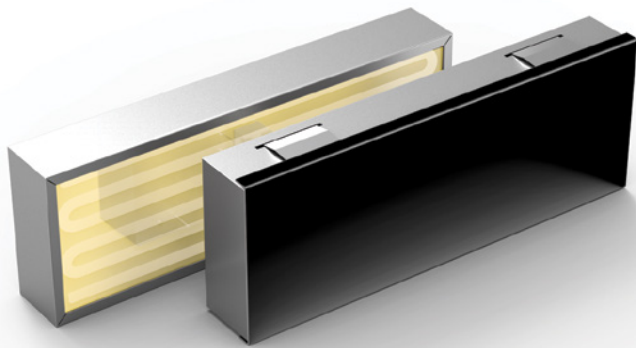

PANEL HEATERS

Useful wavelength range 4 to 6 μ m

They are a neat, easily mounted and readily expanded heating solution.

Infrared panel heaters are custom built infrared heaters operating primarily in the long wave range. The basic construction consists of a resistance coil embedded into a ceramic fibre board which is then located behind an emitting surface of either anodised aluminium or glass ceramic. This is then placed inside a 75mm high aluminised steel housing which normally contains 50mm of thermal insulation to reduce heat loss through the rear of the unit.

Panel Heaters

All dimensions mm Tolerances apply

PANEL HEATERS

STANDARD OPTIONS (Other options available on request. Please contact us for further details.)

- | | |
|--------------------------------|--|
| Emitting surface | <p>Anodised aluminium face - Good radiant efficiency, very robust, surface sheet can be easily cleaned or replaced if damaged by molten material.</p> <p>Glass ceramic face - Very good radiant efficiency, high percentage transmission of radiant output in medium to short wave range, surface can be easily cleaned.</p> |
| Electrical terminations | Open 2P terminal block, Terminal block with cover, M6 or 1/4" threaded stud, Type K thermocouple with fixed high temperature socket and removable plug |
| Fixing studs | M5/M6/M8/0.25" x 25mm long |

Sample panel heater,

Black anodised aluminium face, 270 x 135mm, 500W, 230V, with open 2P terminal block connection.

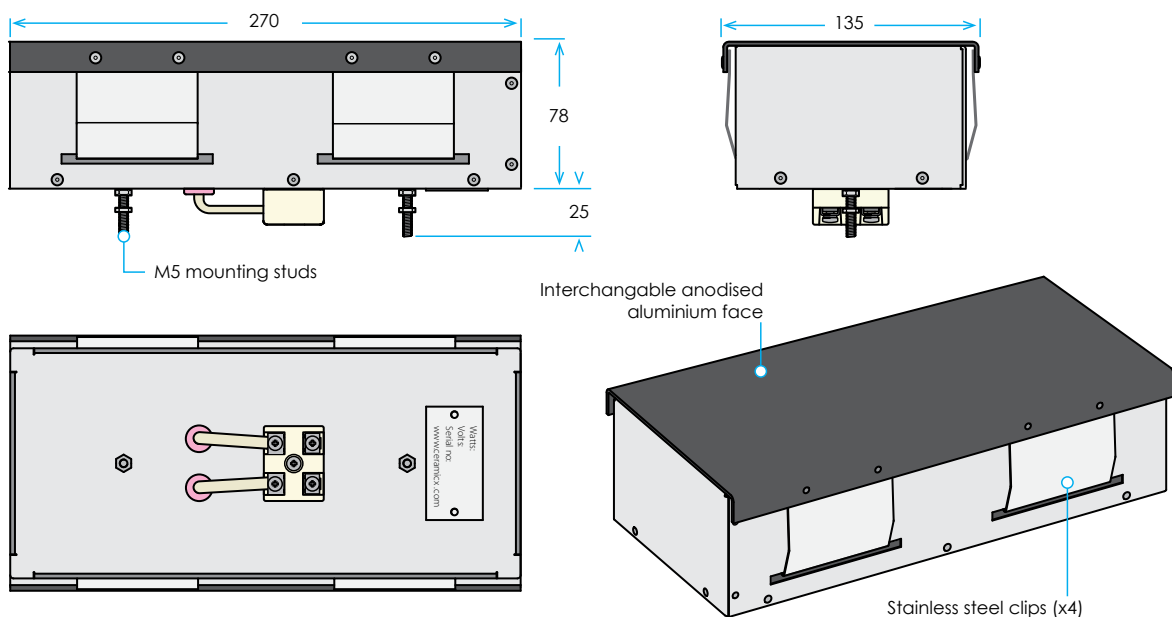

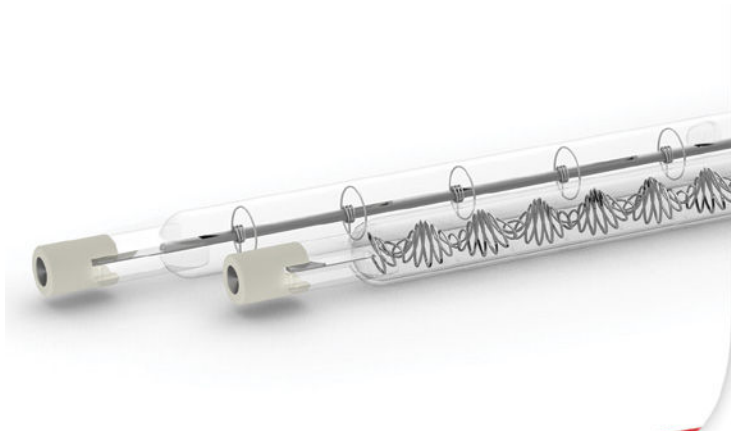

QUARTZ TUNGSTEN/ QUARTZ HALOGEN TUBES

The tungsten filament used in these quartz tungsten heaters is the porcupine or star type coil, which can be operated at temperatures up to 1500°C (2732°F), with a peak wavelength emission of approximately 1.6 microns. It reaches top temperatures within seconds.

Halogen heaters are filled with a halogen gas to allow the supported tungsten filament to reach temperatures as high as 2600°C (4712°F).

Peak emissions for these tubes is around 1 micron.

These emitters heat up and cool down within seconds making them particularly suitable for systems requiring short cycle times.

Quartz Tungsten/Halogen

All dimensions mm Tolerances apply

QTS

Quartz Tungsten Short,

Standard Wattage 750W. Standard Voltage 240V.

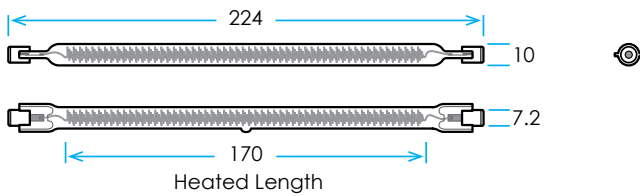

QTM

Quartz Tungsten Medium

Standard Wattage 1000W. Standard Voltage 240V.

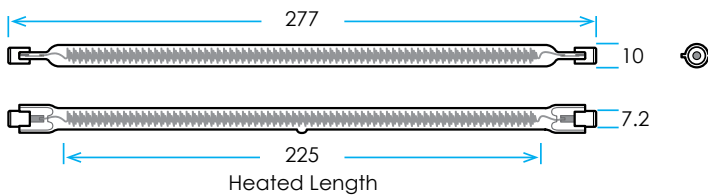

QTL

Quartz Tungsten Long

Standard Wattage 1500W 1750W 2000W. Standard Voltage 240V.

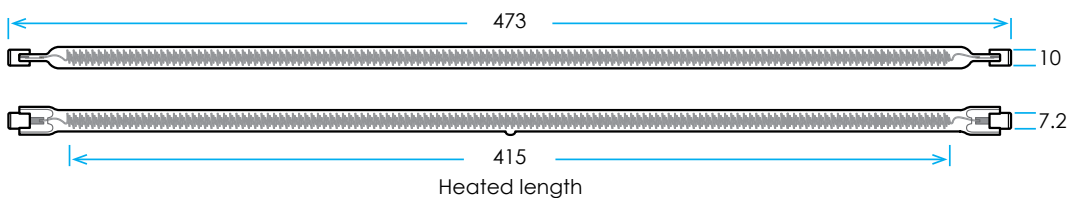

ELEMENT TYPE	WATTS	MAX COIL TEMPERATURE
QTS	750W	1450°C
QTM	1000W	1450°C
QTL	1500W	1270°C
QTL	1750W	1470°C
QTL	2000W	1500°C
QHS	750W	2410°C
QHM	1000W	2410°C
QHL	2000W	2250°C

Coatings



Ceramic



Gold



Ruby

Tube Sizes



Single Tube Twin Tube

Termination Type Single Tube

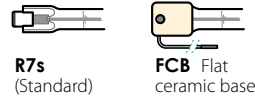

R7s (Standard) FCB Flat ceramic base



MT Metal Tab



SL Sleeve



RCB Round Ceramic Base

Termination Type



R7s (Standard) Ring (M4/M5) Fork (M4/M5)

Coil Type Twin Tube

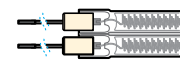

TTF Fast Medium Wave Quartz Tungsten

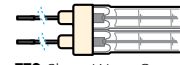

TTS Short Wave Quartz Halogen

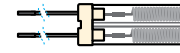

TTL Long Wave Quartz

Coil Type twin tube



Type B Single Sided Connection



Type C Double Sided Connection

QHS

Quartz Halogen Short,

Standard Wattage 750W, 1000W. Standard Voltage 240V.

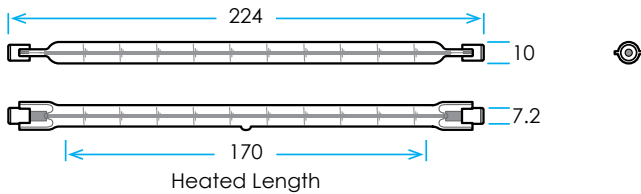

QHM

Quartz Halogen Medium

Standard Wattage 1000W. Standard Voltage 240V.

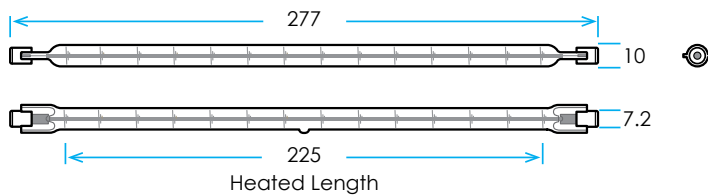

QHL

Quartz Halogen Long

Standard Wattage 2000W. Standard Voltage 240V.

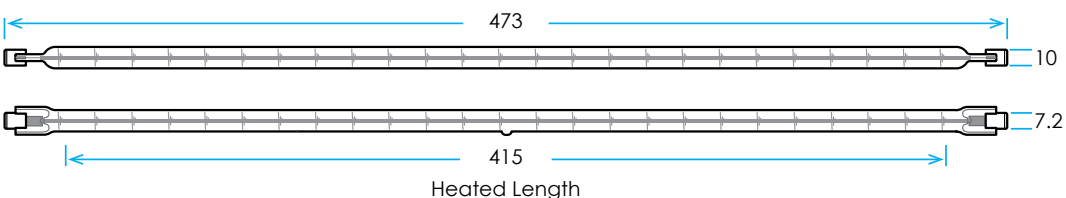



REFLECTORS AND PROJECTORS

Highly reflective aluminised steel projectors and reflectors
 At Ceramicx, our reflectors are designed to cater for a wide range of ceramic and quartz infrared emitters. Units can be mounted individually or side-by-side forming infrared heat panels.
 Our projectors are designed to cater to a wide range of ceramic elements and are the ideal solution where positional heat is required economically, efficiently and quickly.

Reflectors and Projectors

All dimensions mm Tolerances apply

RAS

Reflector Aluminised Steel

Reflector material 0.75mm polished aluminised steel.
 Mounting studs with M6 internal thread. 300mm high temperature leads.

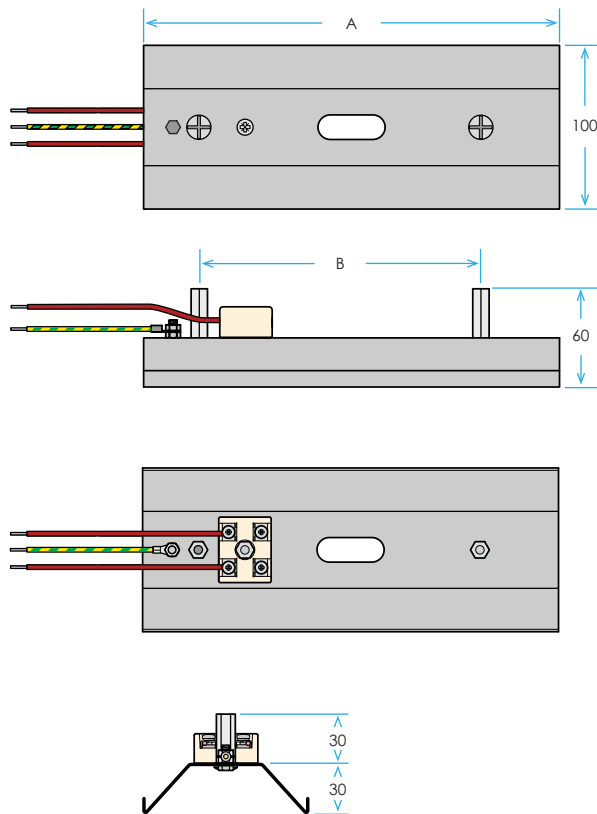

RAS 1 shown as example

RAS 0.5 Suitable for HTE, HFEH and HFE elements.
 Overall length A = 160 mm Distance between fittings B = 131 mm



RAS 1 Suitable for FTE, FFEH and FFE elements.
 Overall length A = 254 mm Distance between fittings B = 175 mm



RAS 2 Suitable for FTE, FFEH and FFE elements.
 Overall length A = 505 mm Distance between fittings B = 278 mm

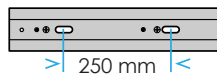

RAS 3 Suitable for FTE, FFEH and FFE elements.
 Overall length A = 754 mm Distance between fittings B = 528 mm

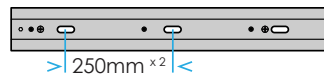

RAS 4 Suitable for FTE, FFEH and FFE elements.
 Overall length A = 1,004mm Distance between fittings B = 778 mm

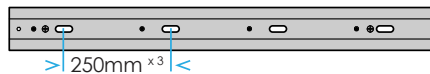

RAS 5 Suitable for FTE, FFEH and FFE elements.
 Overall length A = 1,254 mm Distance between fittings B = 1,028 mm

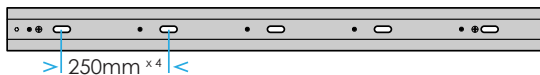

Quartz Tungsten / Halogen Reflectors

Reflector manufactured from 0.75 mm polished aluminised steel.
 2 x M5 fixing bolts
 R7s holders with 200mm leads Ø 0.75mm with PTFE-insulation

QTSR Quartz Tungsten Halogen Short Reflector

Suitable for QTS/QHS tubes with R7s terminations
 Overall length A = 250mm Distance between fittings B = 153mm

QTMR Quartz Tungsten Halogen Medium Reflector

Suitable for QTM/QTM tubes with R7s terminations
 Overall length A = 300mm Distance between fittings B = 203mm

QTLR Quartz Tungsten Halogen Long Reflector

Suitable for QTL/QHL tubes with R7s terminations
 Overall length A = 497mm Distance between fittings B = 400mm

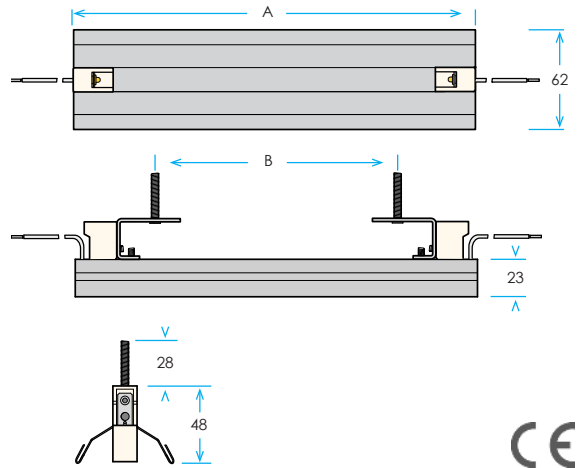

QTSR shown as example

Projector Aluminised Steel

Reflector material 0.75mm polished aluminised steel.
 Ø16 mm metal conduit, length 1.5m

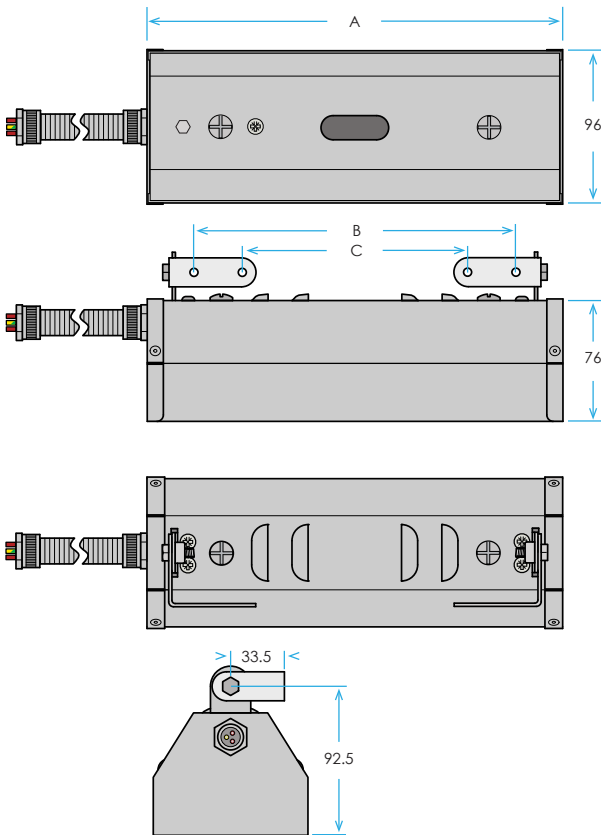

PAS 1 shown as example

PAS 1 Suitable for FTE, FFEH and FFE elements.

Overall length A = 258 mm B = 200mm C = 140mm



PAS 2 Suitable for FTE, FFEH and FFE elements.

Overall length A = 508 mm B = 450mm C = 390mm

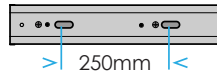

PAS 3 Suitable for FTE, FFEH and FFE elements.

Overall length A = 758 mm B = 700mm C = 640mm

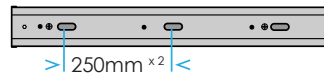

PAS 4 Suitable for FTE, FFEH and FFE elements.

Overall length A = 1,008 mm B = 950mm C = 890mm

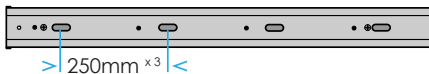

PAS 5 Suitable for FTE, FFEH and FFE elements.

Overall length A = 1,258 mm B = 1,200mm C = 1,140mm

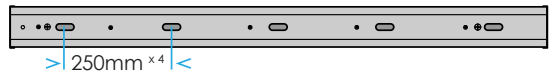



Modular IR Units

MODULAR IR HEATER

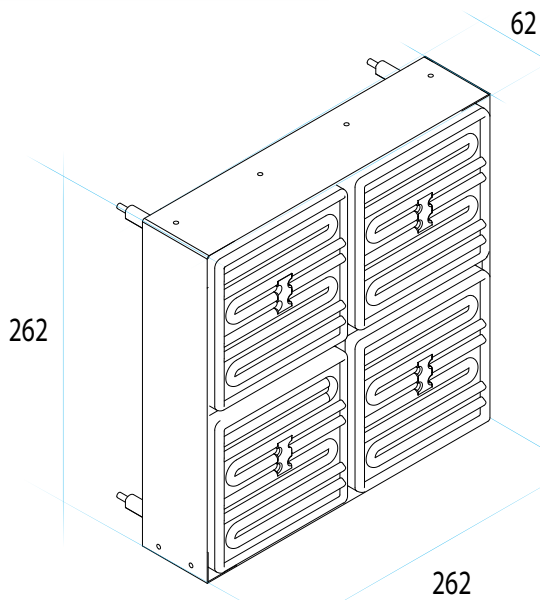

The Modular IR 260 units are designed to maintain equal element spacing when mounted in an array

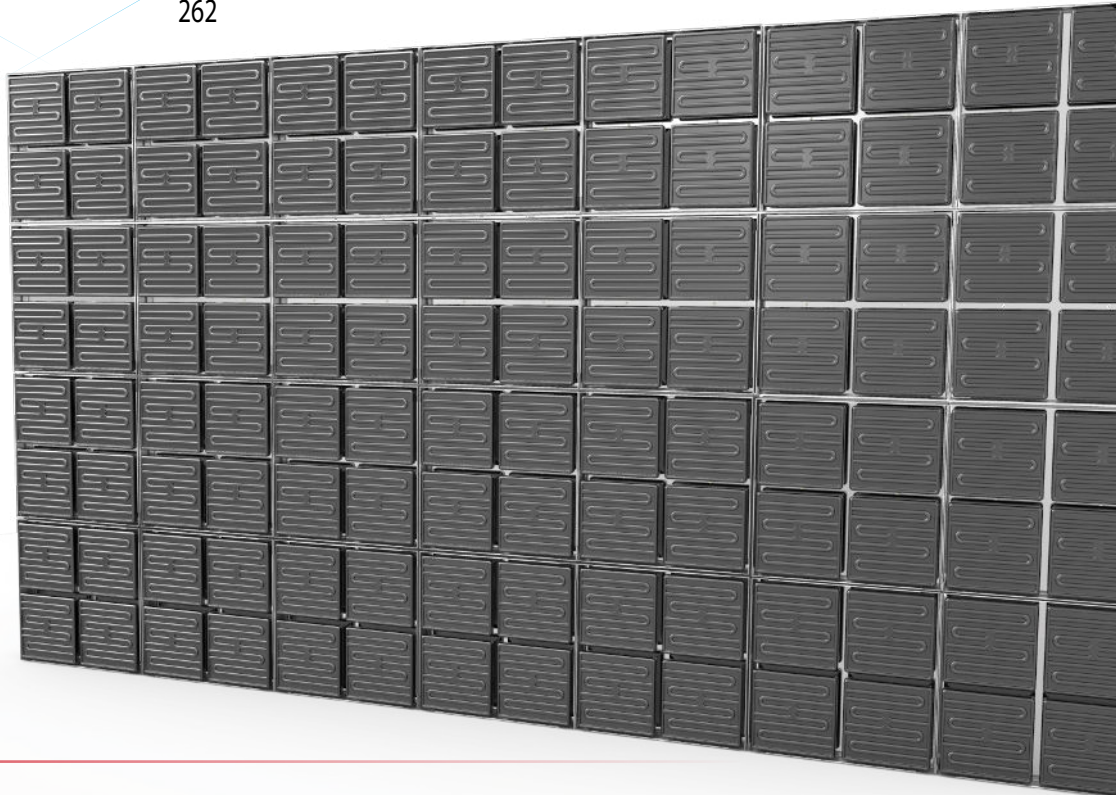

Modular IR 260 – Modular long wave infrared heater allowing multiple units to be arrayed with equal element spacing

Dual voltage 480/240 V (elements can be connected in series or parallel)

Two power output options – 2.4 kW and 1.6 kW

Robust high temperature resistant construction

Fitted with high efficiency black ceramic hollow emitter model SFEH (x 4)

Stainless steel housing

High reflectivity polished aluminised steel reflector plate

Fixed using 4 stainless steel stand off's with M6 threaded screw and fixing nut

Optional type K thermocouple in one of the ceramic emitters

Thermocouple (if installed) connected using removable ceramic type K plug (supplied)

FAST IR

These compact robust systems form an ideal installation for quartz heating elements - quartz tungsten/halogen glass tube emitters. Optimum efficiency is achieved by highly polished aluminium steel reflection and rear mounted axial flow fans, which eliminate rear convection losses and keep the reflectors cool for better directional quality on the infrared output. The external body which is manufactured from aluminium can be maintained at "touch safe" temperature.

Fast IR

All dimensions mm Tolerances apply

FASTIR 305 Suitable for 1000W Quartz tungsten/Halogen heaters QTM or QHM. Standard FastIR 305 designed to hold 4 tubes (4kW), also available as 5 tube (5kW).

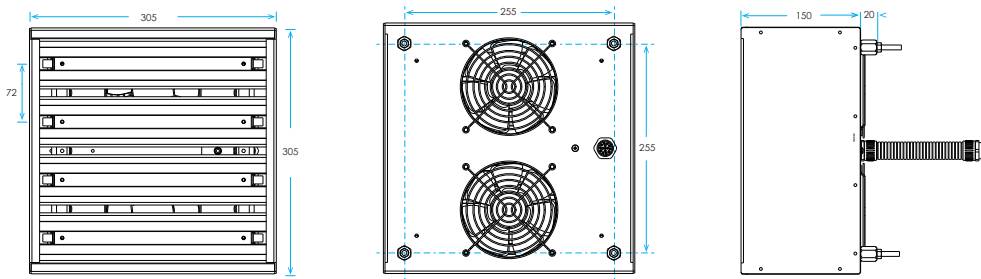

4 x Aluminium stand off with M6 threaded screw with fixing nut.

Electrical termination made via 1.5m of 20mm diameter flexible metal conduit with additional 0.5m of glass fibre insulated NPC conductors. 2 rear mounted axial flow fans.

Suitable for heater type QTM (Quartz Tungsten Medium) or QHM (Quartz Halogen Medium) tubes with R7s termination, 240V (1000W maximum)

See pages 52/53 for full details of tubes



FASTIR 500 Suitable for 1500W, 1750W, 2000W Quartz Tungsten heaters QTL or 2000W Quartz Halogen heaters QHL. Standard FastIR 500 designed to hold 6 tubes (12kW) also available as 7 tube (14kW).

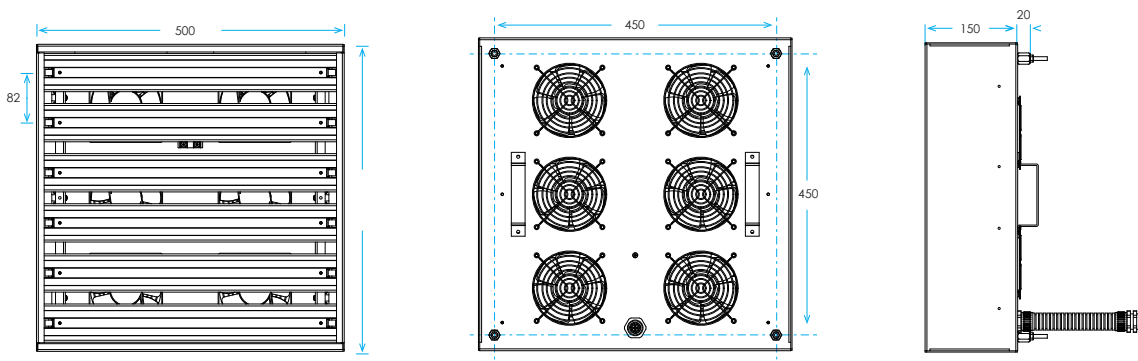

4 x Aluminium stand off with M6 threaded screw with fixing nut.

Electrical termination made via 1.5m of 25mm diameter flexible metal conduit with additional 0.5m of glass fibre insulated NPC conductors. 6 rear mounted axial flow fans.

Suitable for heater types QTL (Quartz Tungsten Long) or QHL (Quartz Halogen Long) tubes with R7s termination, 240V (2000W maximum).

See pages 52/53 for full details of tubes. Please note other configurations are available on request.





Accessories

ACCESSORIES

Ceramicx manufactures a range of accessories, including steatite press components.

Steatite ceramic dust has proven itself to be the material-of-choice for the manufacture of electrical insulators thanks to its good mechanical strength, ideal dielectric properties and high temperature resistivity of up to 1000°C



All dimensions mm Tolerances apply

CERAMIC TERMINAL BLOCKS

2P Ceramic terminal block Stainless steel fittings, body Steatite C-221

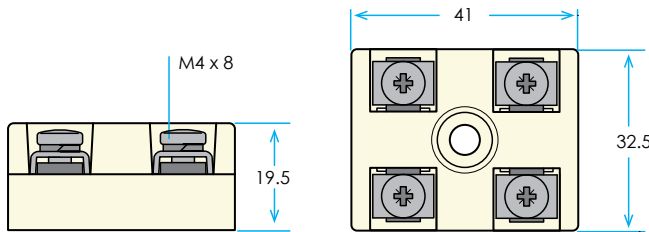

Maximum voltage:	500 V
Maximum temperature:	450 °C
Maximum current:	20 A*
Maximum cable CSA (solid):	4.0 mm sq.
Maximum cable CSA (stranded/with ferrule)	2.5 mm sq.

*Up to 30A permissible at lower temperatures.

2P Mini Ceramic terminal block



Nickel galvanised brass inserts.
Zinc plated steel screws.
21 x 18 x 15 mm

TB2 Ceramic terminal block

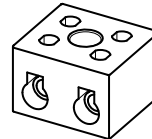

Plated brass inserts.
Nickel galvanised screws.
34 x 30 x 22 mm

TB3 Ceramic terminal block

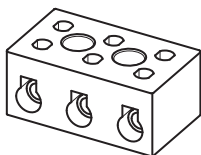

Plated brass inserts.
Nickel galvanised screws.
51 x 30 x 22 mm

2P Ceramic terminal block no fittings

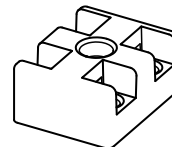

41 x 32.5 x 9.5 mm

CERAMIC BEADS

Ceramic beads 1 Kg bag

Material: Steatite C-221

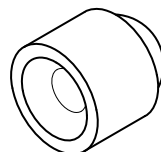
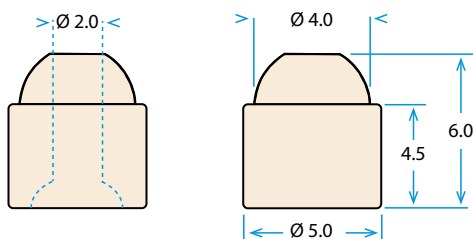

Ceramic tubes



Ø5 x 11.5 mm
Material: Steatite C-221

High temperature NPC cable

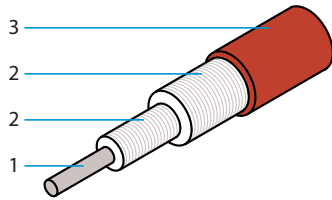

1. Flexible nickel plated copper core
2. Multiple silicone-impregnated glass lapping
3. Silicone - coated fibreglass braid

Continuous working temperature: -60°C to +280°C
 Peaks at 350°C
 Working voltage: 300/500V

Nominal core cross-section	Nominal core stranding	Outer cable diameter	Linear weight approx
0.75 mm ²	11 x 0.30	2.4 mm	11.9 kg/km
1.50 mm ²	21 x 0.30	2.8 mm	20.5 kg/km
2.50 mm ²	35 x 0.30	3.2 mm	32.2 kg/km
4.00 mm ²	56 x 0.30	4.0 mm	50.1 kg/km

Fibre glass braided sleeving

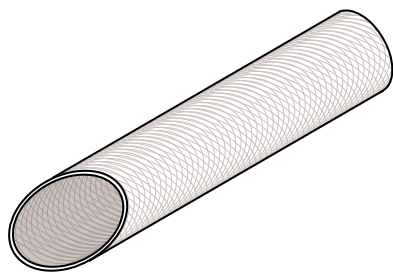

Fibre glass braided sleeving non-impregnated
 Continuous working temperature: -60°C to +450°C



Nominal Inner diameter	Min. wall thickness	Linear weight approx
2 mm	0.20	3.10 kg/km
4 mm	0.30	7.60 kg/km
6 mm	0.30	12.00 kg/km

Grommet set

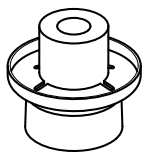

Ceramic grommet and star-lock fastener set, used as insulator in sheet metal with 6mm hole
 9.5 x 7.5 mm

Stainless steel buss bar

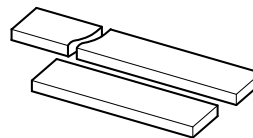

Used with the ceramic terminal block to produce a flexible power distribution system
 8 x 2 x 1000 mm

Steel wave and spring clip

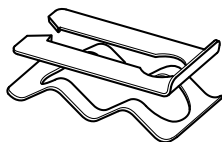

Used in the mounting and instillation of all Ceramic and pillared quartz elements

R7s ceramic holder

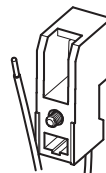

For standard quartz tungsten tubes and quartz halogen tubes



ceramicx

INFRARED FOR INDUSTRY

Ceramicx Ltd. Gortnagrough, Ballydehob, Co. Cork, P81 HO26, Ireland.

Tel. +353 28 37510 sales@ceramicx.com www.ceramicx.com



QUALITY
ISO 9001:2015
NSAI Certified