

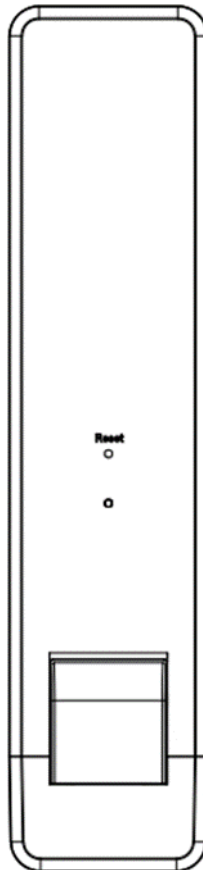

**Data Transfer Unit
DTU-W100
User Manual**



Corporate Headquarters Contact Information

Hoymiles Converter Technology Co.,Ltd.

No.18 Kangjing Road,

Hangzhou 310015,

China

www.hoymiles.com

info@hzconverter.com

Table of Contents:

1.Important Safety Information.....	4
Foreword.....	4
Safety Instructions.....	4
2.The monitoring system of Hoymiles.....	5
3. DTU Installation Operation.....	6
3.1 Install The DTU.....	6
3.2 WIFI Configuration Process.....	7
3.3 Boot Process.....	9
3.4 Indicator Light Status Description.....	9
4.Improve Installation Maps And Record Archives.....	10
5.Server side browsing.....	11
6.Mobile APP view power station information.....	12
7.Specifications.....	14

1.Important Safety Information

Foreword

This manual contains important instructions to follow during installation and maintenance of the Hoymiles Data Transfer Unit(DTU)



Safety Instructions

- Only qualified personnel can install or replace the DTU.
- Do not attempt to repair the DTU as it contains the parts that are not serviceable to users. If the DTU breaks down, please contact your distributor for maintenance. Opening the DTU without permission will invalidate the warranty.
- Please read all technical instructions and cautions in this manual and on the DTU before installing and using DTU.

Audience

This manual is only for professional installation and maintenance personnel to use.

Symbols replace words on the equipment, on a display, or in manuals.

Trademark	
Symbols	Explanation
	DC voltage
	<p>RECYCLING</p> <p>This product bears the selective sorting symbol for Waste electrical and electronic equipment (WEEE). This means that this product must be handled pursuant to European directive 2012/19/EU in order to be recycled or dismantled to minimize its impact on the environment.</p> <p>User has the choice to give his product to a competent recycling organization or to the retailer when he buys a new electrical or electronic equipment.</p>
	Use only power supplies listed in the user instructions

2.The monitoring system of Hoymiles

The DTU is the key component in Hoymiles monitoring system. It is the relay station of the monitoring system, which operates between the Hoymiles microinverters and the Hoymiles Monitoring Server. The DTU communicates with the microinverters in the system via 2.4G RF wireless to collect the data and status of the microinverters in the system. At the same time, DTU connects to the Internet through WIFI, which realizes the information exchange with the Hoymiles cloud monitoring service platform and sends all the running data of microinverters and status of the system to the Hoymiles cloud monitoring server. It receives the control commands from the cloud monitoring server and sends the data to the microinverters in the system to achieve remote operation and maintenance.

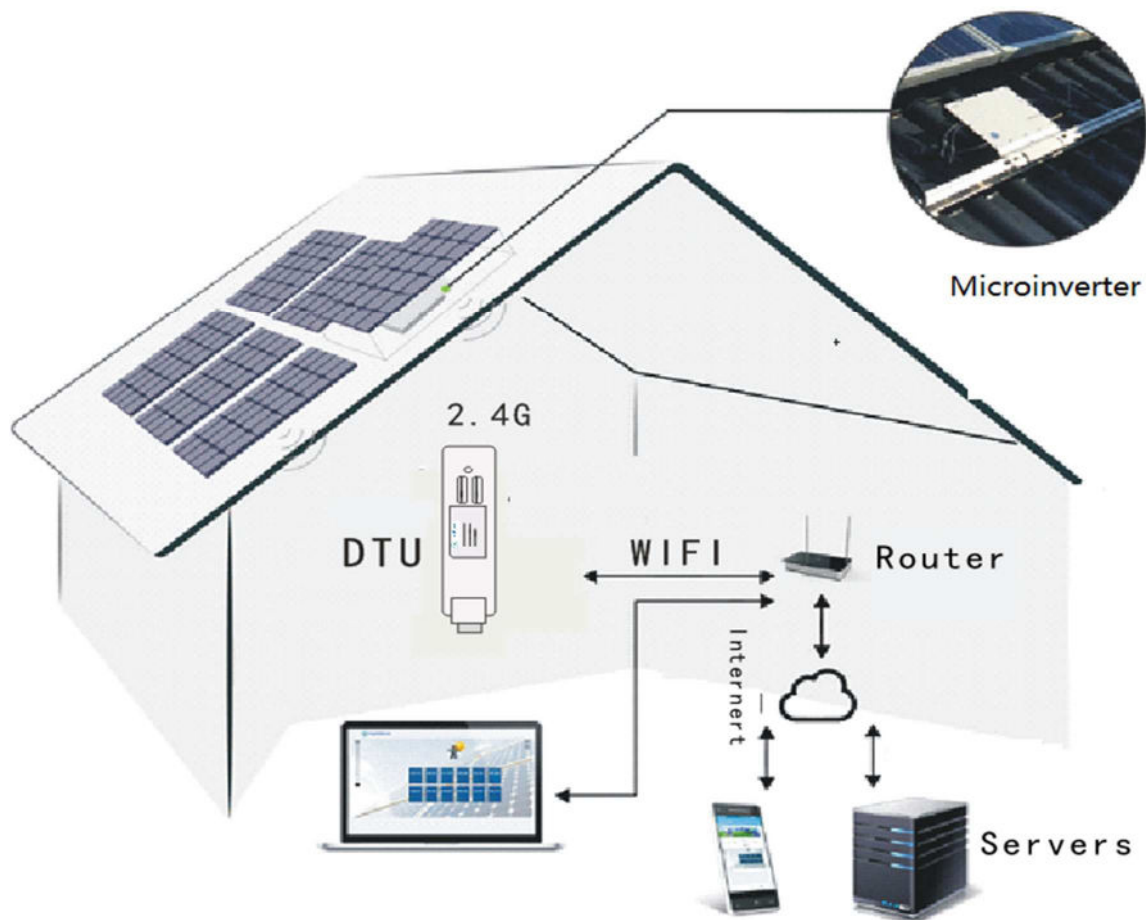

Other Elements in the Hoymiles Microinverter System

The Microinverter: It converts the DC output of solar modules into grid-compliant AC power. It sends the output electrical information of PV panels and the operation data of the microinverters to the DTU, which is the hardware basis of the panel-level monitoring. With efficiency up to 96.7% and MPPT efficiency up to 99.9%, Hoymiles microinverters rank in the first level around the world in 2015.

The Hoymiles Monitoring Server: It collects the operation data and status of the microinverters in the system, and provides the panel-level monitoring for the users and maintenance staffs to achieve remote operation and maintenance, which can improve operational and maintenance efficiency.

3. DTU Installation Operation

3.1 Install The DTU

1. Plug the DTU connection adapter into the wall socket (the wall socket should be more than 1 meter above the ground).

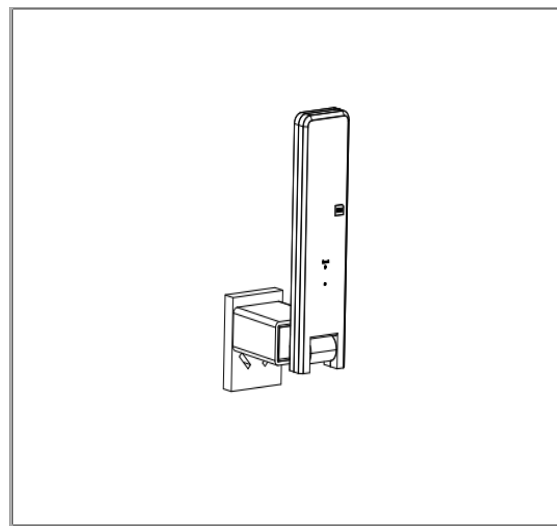
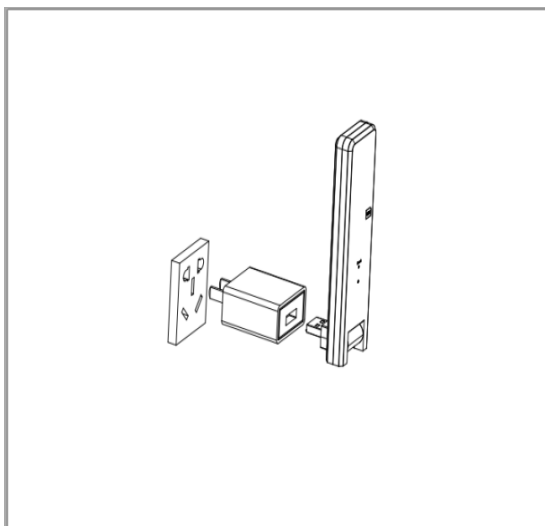

2.Or plug the DTU into the power adapter and plug it into the cable outlet. Place the socket on the table (when the table is placed, the table surface should be more than 1 meter above the ground).

Note: The table should not be metal or concrete structure (to prevent the effects on 2.4G RF signal).

3.The DTU is placed as far as 90 degrees vertically upwards.

4.The distance between the DTU and the router should be as close as possible.

3.2 WIFI Configuration Process

Connect the wireless name of DTUW- via computer or mobile phone, and then open the browser and enter 10.10.100.254 to open the wifi configuration page. The username and password are 'admin' by default. After entering, click the wifi parameter menu on the left menu bar to enter the wifi parameter configuration. Then click the search button in the lower right corner, select the wifi name to be connected to the DTU and enter the password, then click Save and click Restart next.

Note: Non-professionals should not modify other parameters.

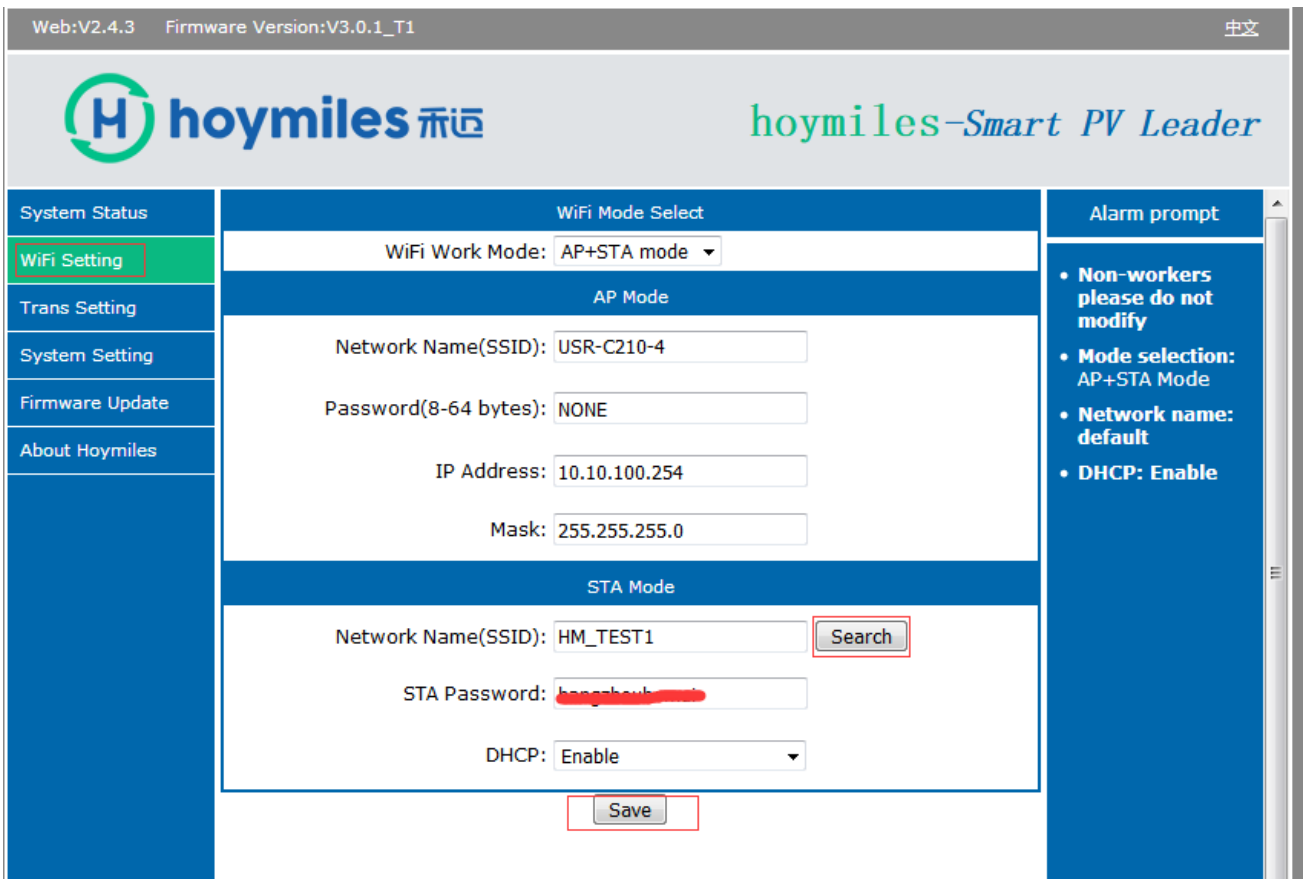

Web:V2.4.3 Firmware Version:V3.0.1_T1 中文

hoymiles 禾运 *hoymiles-Smart PV Leader*

System Status

WiFi Setting

Trans Setting

System Setting

Firmware Update

About Hoymiles

WiFi Mode Select

WiFi Work Mode: AP+STA mode

AP Mode

Network Name(SSID): USR-C210-4

Password(8-64 bytes): NONE

IP Address: 10.10.100.254

Mask: 255.255.255.0

STA Mode

Network Name(SSID): HM_TEST1 Search

STA Password: [REDACTED]

DHCP: Enable

Save

Alarm prompt

- Non-workers please do not modify
- Mode selection: AP+STA Mode
- Network name: default
- DHCP: Enable

Please select a SSID

WiFi Setting	Site Survey			
	SSID	BSSID	RSSI	Channel
<input type="radio"/>	HM_NewE	0A:25:93:DA:8A:60	-28	9
<input type="radio"/>	HM_Engineering	88:25:93:DA:8A:60	-30	9
<input checked="" type="radio"/>	HM_TEST1	BC:14:EF:CF:76:30	-40	12
<input type="radio"/>	CN-TEST-1	D8:B0:4C:C2:95:8B	-48	9
<input type="radio"/>	HM-OFFICE-1	08:9B:4B:94:D2:15	-67	6
<input type="radio"/>	HM-OFFICE-2	0E:9B:4B:94:D2:15	-67	6
<input type="radio"/>	WeiXiuShi	B0:95:8E:2C:FB:E5	-85	11

OK Refresh

Alarm prompt

- Non-workers please do not modify
- Mode selection: AP+STA Mode
- Network name: default
- DHCP: Enable

STA Mode

Network Name(SSID): Search

STA Password:

DHCP:

Save

Save Success

Save Success!
Configurations will take effect after restart.
After restart, you will need to re-login the configuration interface for other settings, so it is recommended to restart after completing all settings.
Please click [Restart] to restart now, or click [Back] to continue setting.
You can restart after all configuration.

Restart

3.3 Boot Process

When the DTU starts to work, the red, green and blue lights are on for one second, then the red light is on. The green light flashes to indicate that the search is slightly reversed and connected to WIFI. The red and green lights flash alternately to indicate that the server is connected and the WIFI is searched. After the search, the green light stops flashing and turns solid.















3.4 Indicator Light Status Description

LED light		DTU status			
		Red	Blue	Green	Red+Blue+Green
1	Power-on				Alternate Bright (1s)
2	Upgrade procedure				Alternate Shining (1/3s)
3	normal operation			Bright	
4	ID search is not complete			Shining	
5	Not ID		Bright		
6	Not connected to WIFI	Bright			
7	Server not connected	Shining			
8	Receive server data		Shining		

4.Improve Installation Maps And Record Archives

- 1.Check if the indicator light is normal.
- 2.Confirm whether the connection is successful.
3. Please improve the installation map.
- 4.Remove the DTU serial number and attach it to the blank field of the DTU serial number on the installation map.

To sheet _____

N (S) E W (circle or o)		Panel Group: South roof Azimuth: South Tilt: 30° Sheet 1 of 1		Customer Information: Zhang San No.18 Kangjiao Road, Hangzhou Zhangsan@gmail.com		DTU Serial Number:  10D033402524								
	1	2	3	4	5	6	7	8	9	10	11	12	13	14
A														
B														

5. record archive

User address	DTU	Roof type	capacity	Installation date
Country+City+User name	10D133402524	Wooden sloping roof	3KW	2018-10-01

5. Server side browsing

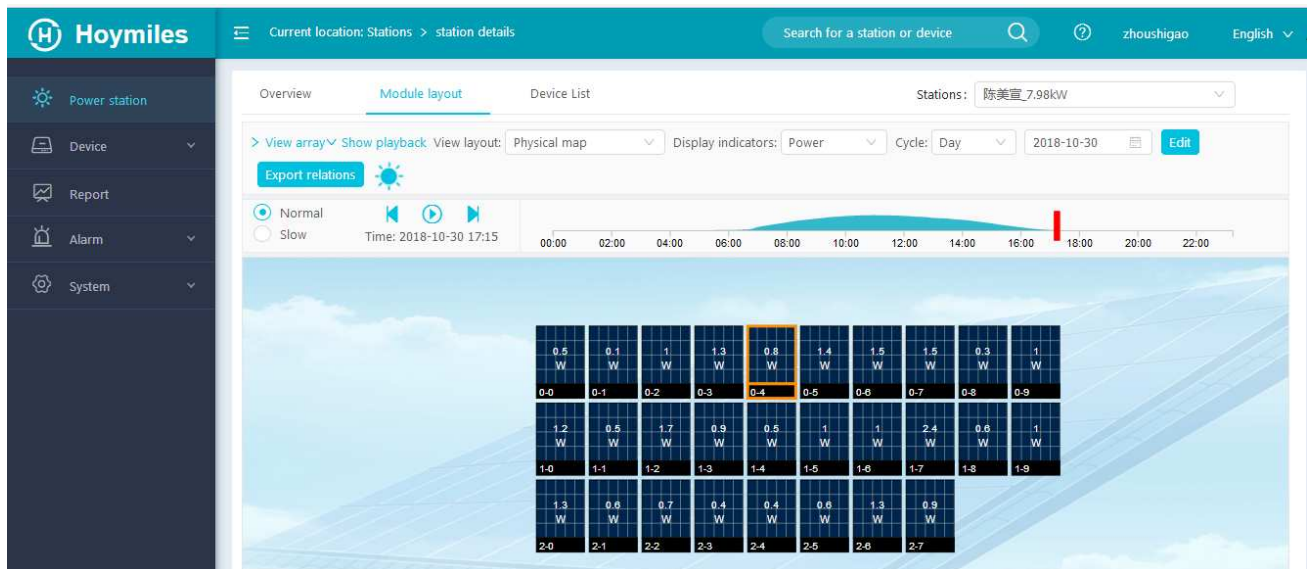

6.Mobile APP view power station information

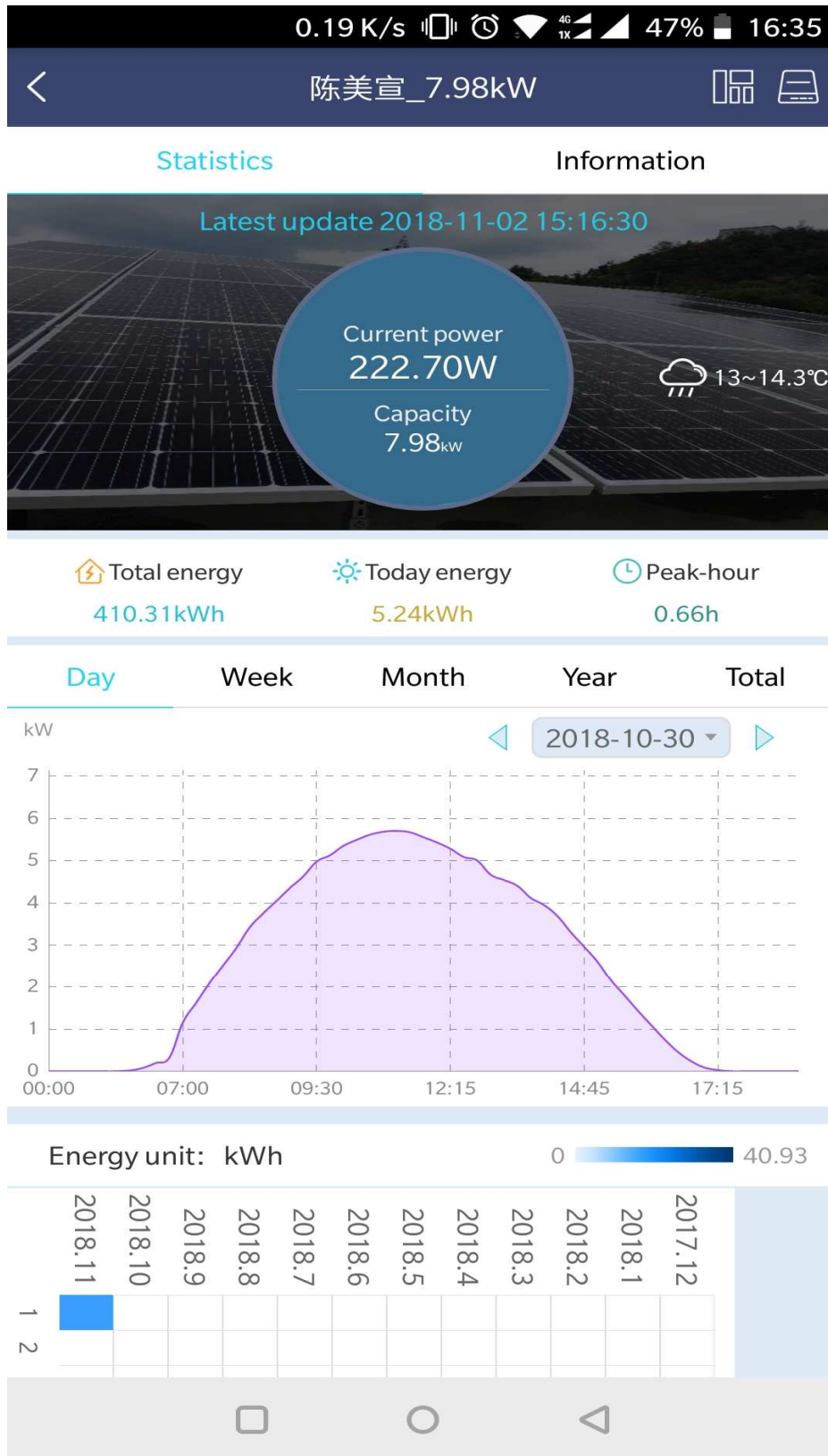

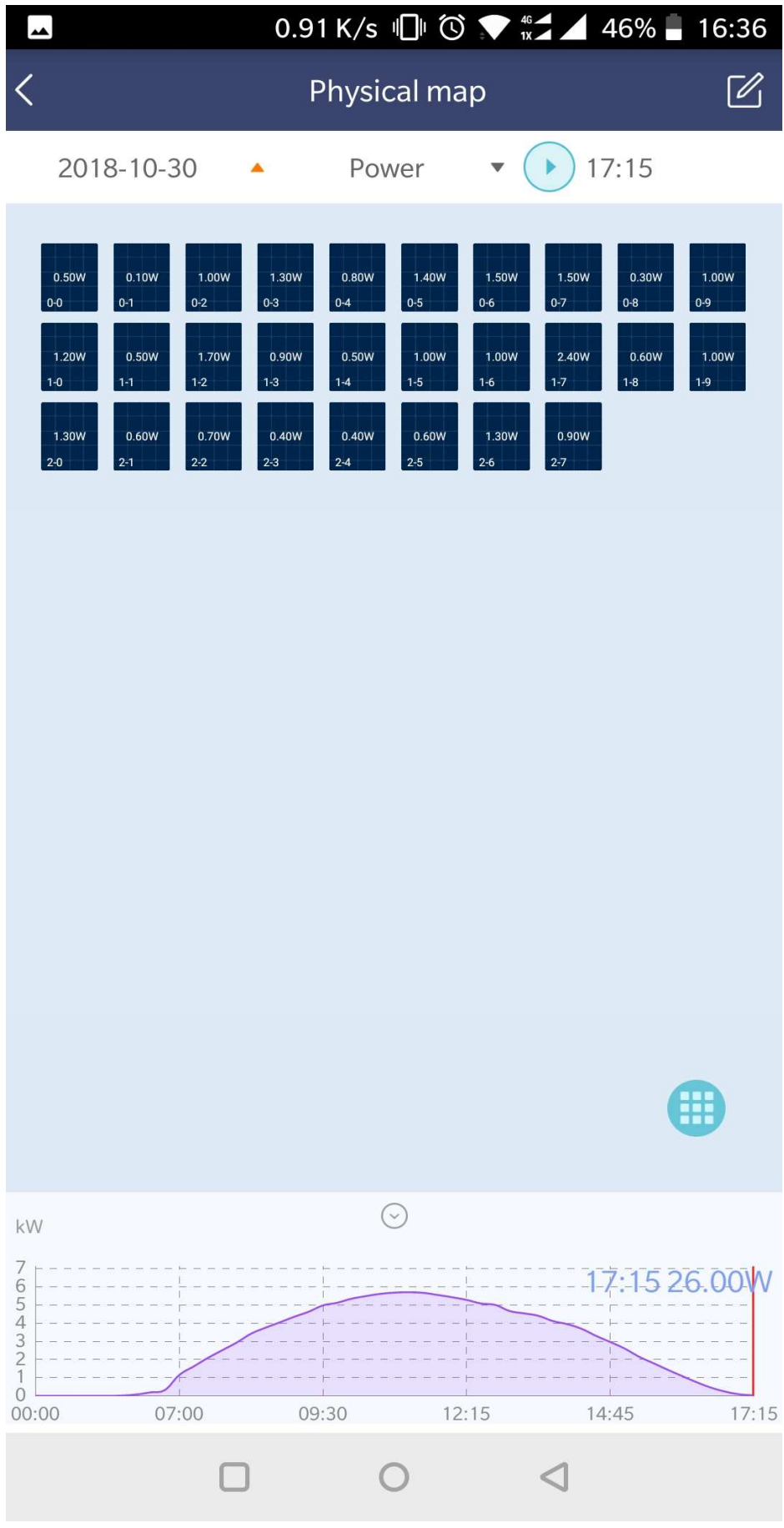

7. Specifications

Model	DTU-W100
RF communication	
Communication method	2.4G RF
Communication frequency	2400MHz to 2483.5MHz
Number of channels	5
Communication distance (empty environment)	200Meter
Maximum number of components that can be connected	99 MI-250 ,49 MI-500, or 24 MI-1000
Telecommunication	
WIFI communication standard	802.11b/g/n
Data upload time	15 minutes
Power Supply	
Power supply	External adapter
Adapter input voltage / frequency	100 to 240 V AC / 50 or 60Hz
Adapter output voltage / current	5V / 1A
Power consumption	0.8W (normal)
Mechanical Data	
Ambient temperature range (°C)	-20°C to 55°C
Size (W×H×D)	143mm×33mm×12.5mm
Weight	0.1kg
Mounting system	Direct power supply
Display	LED
Features	
Standard	IEC60950 IEC61000-6-2 FCC Part15 Class B / Class C
Standard warranty	2 years



FCC Statement

This device complies with Part 15 of the FCC Rules. Operation is subject to the following two conditions: (1) This device may not cause harmful interference, and (2) this device must accept any interference received, including interference that may cause undesired operation.

NOTE: This equipment has been tested and found to comply with the limits for a Class B digital device, pursuant to Part 15 of the FCC Rules. These limits are designed to provide reasonable protection against harmful interference in a residential installation. This equipment generates uses and can radiate radio frequency energy and, if not installed and used in accordance with the instructions, may cause harmful interference to radio communications. However, there is no guarantee that interference will not occur in a particular installation. If this equipment does cause harmful interference to radio or television reception, which can be determined by turning the equipment off and on, the user is encouraged to try to correct the interference by one of the following measures:

- Reorient or relocate the receiving antenna.
- Increase the separation between the equipment and receiver.
- Connect the equipment into an outlet on a circuit different from that to which the receiver is connected.
- Consult the dealer or an experienced radio/TV technician for help.

WARNING: Any changes or modifications not expressly approved by the party responsible for compliance could void the user's authority to operate this equipment.

The device must not be co-located or operating in conjunction with any other antenna or transmitter.

IC Statement

This device complies with Industry Canada licence-exempt RSS standard(s). Operation is subject to the following two conditions: (1) this device may not cause interference, and (2) this device must accept any interference, including interference that may cause undesired operation of the device.

Under Industry Canada regulations, this radio transmitter may only operate using an antenna of a type and maximum (or lesser) gain approved for the transmitter by Industry Canada. To reduce potential radio interference to other users, the antenna type and its gain should be so chosen that the equivalent isotropically radiated power (e.i.r.p.) is not more than that necessary for successful communication.

Conformément à la réglementation d'Industrie Canada, le présent émetteur radio peut fonctionner avec une antenne d'un type et d'un gain maximal (ou inférieur) approuvé pour l'émetteur par Industrie Canada. Dans le but de réduire les risques de brouillage radioélectrique à l'intention des autres utilisateurs, il faut choisir le type d'antenne et son gain de sorte que la puissance isotrope rayonnée équivalente (p.i.r.e.) ne dépasse pas l'intensité nécessaire à l'établissement d'une communication satisfaisante.

Le présent appareil est conforme aux CNR d'Industrie Canada applicables aux appareils radio exempts de licence. L'exploitation est autorisée aux deux conditions suivantes : (1) l'appareil ne doit pas produire de brouillage, et (2) l'utilisateur de l'appareil doit accepter tout brouillage radioélectrique subi, même si le brouillage est susceptible d'en compromettre le fonctionnement.

The device must not be co-located or operating in conjunction with any other antenna or Transmitter.

To comply with FCC's and Industry Canada's RF radiation exposure limits for general population/uncontrolled exposure, this device must be installed to provide a separation distance of at least 20cm from all persons.